

Instructions to printer
DO NOT PRINT THIS PAGE

This document is intended to be printed in **color** as a 5.9 x 5.9 inch (150 mm square) booklet with saddle-stitched (stapled) binding.
Use high-quality, glossy 20 lb (75 g/m²) paper.

QUICK START GUIDE

GFK-2891D

Sep 2019

PACSystems™ RX3i

GENIUS™ COMMUNICATION GATEWAY
(IC695GCCG001)



Contents

1	User Features.....	1
1.1	Ethernet Ports	2
1.2	Genius Serial Bus Connector.....	2
1.3	Power Connector.....	3
1.4	Rear of Module Features	3
1.5	Light-Emitting Diode Indicators (LEDs)	5
2	Hardware Installation	8
2.1	Initial Checks	8
2.2	Installation Location	8
2.3	Installation in Hazardous Areas	9
2.4	Module Installation	10
3	Configuration.....	13
3.1	You Will Need:	13
3.2	Basic Configuration Steps	13
	Additional Information	16

Caution Notes as Used in this Publication



Warning notices are used in this publication to emphasize that hazardous voltages, currents, temperatures, or other conditions that could cause personal injury exist in this equipment or may be associated with its use. In situations where inattention could cause either personal injury or damage to equipment, a Warning notice is used.

Warning

Note: Notes merely call attention to information that is especially significant to understanding and operating the equipment.

These instructions do not purport to cover all details or variations in equipment, nor to provide for every possible contingency to be met during installation, operation, and maintenance. The information is supplied for informational purposes only, and Emerson makes no warranty as to the accuracy of the information included herein. Changes, modifications, and/or improvements to equipment and specifications are made periodically and these changes may or may not be reflected herein. It is understood that Emerson may make changes, modifications, or improvements to the equipment referenced herein or to the document itself at any time. This document is intended for trained personnel familiar with the Emerson products referenced herein.

Emerson may have patents or pending patent applications covering subject matter in this document. The furnishing of this document does not provide any license whatsoever to any of these patents.

Emerson provides the following document and the information included therein as-is and without warranty of any kind, expressed or implied, including but not limited to any implied statutory warranty of merchantability or fitness for particular purpose.

1 User Features

The RX3i Genius Communications Gateway, IC695GCG001, or **GCG001**, interfaces Genius I/O devices on a Simplex Genius serial bus to a Emerson PROFINET I/O Controller or CPE330 CPU^A. The GCG001 operates as a Genius Bus Controller on a Genius network. It scans the Genius I/O devices configured to it, retrieving input data and providing output data, and exchanges that data with its configured PROFINET I/O Controller over its Ethernet interfaces at the configured production rate. If the Ethernet network or Genius serial bus communications are lost, the GCG001 manages I/O states according to the individual module configurations. The GCG001 can manage communications for up to 31 Genius I/O devices on a single Genius Serial Bus.

Figure 1: Module Features

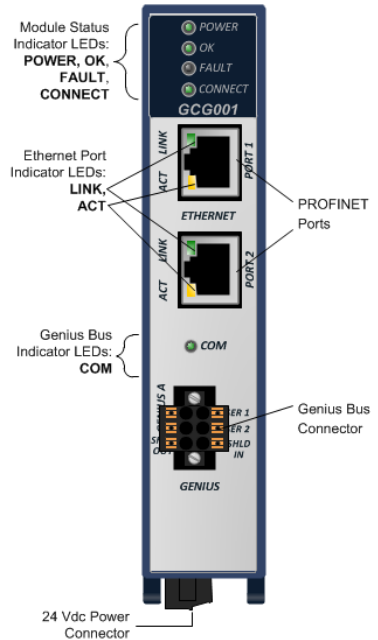

^A In addition to the PNC001, beginning with version 8.90, the CPE330 CPU is capable of controlling a GCG001 on a PROFINET network. No other PROFINET controllers are supported.

1.1 Ethernet Ports

The GCG001 provides two RJ-45 Ethernet ports for connection to a Emerson PROFINET controller. Although the hardware supports the 10/100BASE TX Ethernet standard, PROFINET I/O over wired infrastructure must be 100Mbps full-duplex or faster. 10Mbps should not be used for PROFINET. Each port automatically detects the attached cable and functions properly with either straight-through or crossover cables.

Each port on the GCG001 operates independently through an embedded Ethernet switch. The switch permits the network to be daisy-chained through the GCG001 to other I/O devices.

Figure 2: Ethernet Port

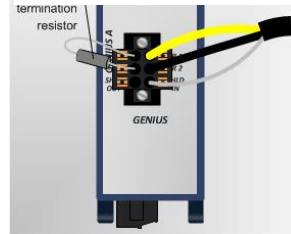

1.2 Genius Serial Bus Connector

The GCG module is equipped with one active six-terminal Genius Serial Bus connector. Two terminals each are provided on a removable terminal block connector for Serial 1, Serial 2, and Shield connections. When the bus is terminated at the GCG001, a bus termination resistor should connect Serial 1 to Serial 2, with SHLD OUT unterminated.

Figure 3: Serial Bus Connector



When the GCG001 is not at the end of the bus, the two sets of terminals accommodate two bus cables as shown at right. The Genius bus will continue to operate even in the absence of power to the GCG001. (Removing the connector, however, will disrupt the Genius bus.)

1.3 Power Connector

The module requires a user-supplied 24 Vdc ($\pm 10\%$) power source wired to a removable screw-terminal block located on the bottom of the module. The module draws 0.2 A maximum current.

Figure 4: Power Connector

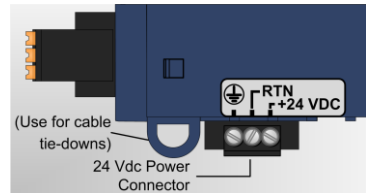

1.4 Rear of Module Features

Two seldom-needed features are accessed from the rear of the module: an SD card slot and a firmware load pushbutton. These are described in the following paragraphs.

Figure 5: Rear View of Module

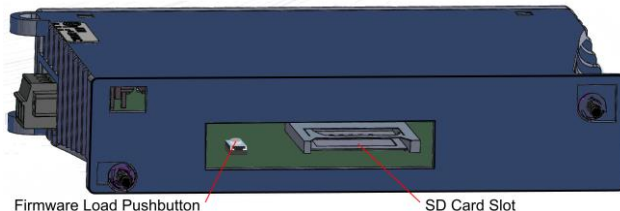

1.4.1 Secure Digital (SD) Card Slot

The SD card slot is designed to support a Secure Digital (SD) non-volatile memory card in standard capacity format. This optional card has two distinct uses: (1) backup storage of some key PROFINET configuration data and (2) loading new module firmware.

1.4.2 Backup Storage

For use as configuration back-up storage, a small SD card is inserted and left in place. The module will detect the card automatically and store on it a small amount of configuration data. If the GCG001 must be replaced in the event of a failure, remove the SD card from the failed unit and install it in the replacement prior to mounting. All PROFINET configuration data will then be transferred to the replacement module.

Note: *SD cards larger than 2 GB are not supported for use with with the GCG001. SDHC and SDXC formats are **not** supported.*

1.4.3 Firmware Load Pushbutton





The Firmware Load Pushbutton is used to initiate loading of module firmware from the SD card as described in the next section.

1.4.4 Loading New Firmware



To load new GCG001 firmware, the SD card must be moved to a computer. Copy the firmware image to the card, then re-insert the card into the unpowered GCG001's SD slot. Next, while holding down the Firmware Load Pushbutton, apply power to the module. Continue holding the pushbutton until the **OK** LED turns amber, then release the pushbutton. When the **OK** LED turns green, the firmware is loaded. Finally, cycle power on the module and wait for the **OK** LED to turn green and steady.

1.5 Light-Emitting Diode Indicators (LEDs)



POWER – indicates the presence of power to the module.

	Green, ON steady	Power supply is good.
	Green/Amber, blinking	Module loading main operating system
	Amber, ON steady	Module loading bootloader operating system
	OFF	Power supply is off or not good.



OK – indicates module readiness to perform normal operations.

	Green, ON steady	Module able to perform normal operations.
	OFF	Module has an unrecoverable fault or power is not applied.



FAULT – indicates the detection of faults by the module.

	OFF	No faults present.
	Red, blinking	DCP Device Identification signal received on PROFINET.
	Red, ON	A fault or other PROFINET diagnostic data exists on the Gateway



CONNECT – indicates a connection to a PROFINET controller.

 OFF	One or more connections with Emerson PROFINET Controllers have been established to this device.
 Red, blinking	Device trying to connect to a controller. Continuous if device has not been assigned a valid station name.
 Red, ON	No PROFINET Controller connection



PORT 1, PORT 2 LINK – indicates connection status on Ethernet ports.

 Green, ON steady	Ethernet connection established
 OFF	No Ethernet connection

PORT 1, PORT 2 ACT – indicates activity on PROFINET ports.

 Amber, blinking	Communications occurring on port
 OFF	No communication

COM – indicates the status of Genius Bus communications.

 Green, ON steady	The Genius Bus is configured and operating properly.
 Green, blinking	A Genius Bus error has been detected.
 OFF	The Genius Bus has failed or no Genius Bus configuration has been received.

2 Hardware Installation

2.1 Initial Checks

Upon receiving your RX3i equipment, carefully inspect all shipping containers for damage. If any part of the system is damaged, notify the carrier immediately. The damaged shipping container should be saved as evidence for inspection by the carrier.

As the consignee, it is your responsibility to register a claim with the carrier for damage incurred during shipment. Emerson will fully cooperate with you, however, should such action be necessary.

After unpacking the RX3i equipment, record all serial numbers. Serial numbers are required if you should need to contact Customer Care during the warranty period. All shipping containers and all packing material should be saved should it be necessary to transport or ship any part of the system.

Verify that all components of the system have been received and that they agree with your order. If the system received does not agree with your order, contact Customer Care.

2.2 Installation Location

This product is intended for use with the RX3i system. Its components are considered open equipment (having live electrical parts that may be accessible to users) and must be installed in an ultimate enclosure that is manufactured to provide safety. As a minimum, the enclosure shall provide a degree of protection against solid objects as small as 12mm (e.g. fingers). This equates to a NEMA/UL Type 1 enclosure or an IEC60529 IP20 rating providing at least a pollution degree 2 environment. For details about installing RX3i rack systems, refer to GFK-2314.

If you need technical help, contact Technical Support. For phone numbers and email addresses, see the back cover of this Guide.

2.3 Installation in Hazardous Areas

The following information is for products bearing the UL marking for Hazardous Areas or ATEX marking for explosive atmospheres:

2.3.1 CLASS 1 DIVISION 2 GROUPS ABCD

- This equipment is an open-type device and is meant to be installed in an enclosure suitable for the environment that is only accessible with the use of a tool.
- Suitable for use in Class I, Division 2, Groups A, B, C and D Hazardous Locations, or nonhazardous locations only.

WARNING

- Explosion hazard - Substitution of components may impair suitability for class I, division 2.
 - When in hazardous locations, turn off power before replacing or wiring modules; and
 - Do not connect or disconnect equipment unless power has been switched off or the area is known to be nonhazardous.
 - Explosion hazard - USB port is only for use in nonhazardous locations, do not use unless area is known to be non-hazardous.
-

2.3.2 ATEX Zone 2

The GCG001 must be mounted in an enclosure certified in accordance with EN60079-15 for use in Zone 2, Group IIC and rated IP54. The enclosure shall only be able to be opened with the use of a tool.

2.4 Module Installation

The GCG001 is designed to mount over the expansion slot of an RX3i Universal Backplane. It may alternately be mounted directly on a panel. In both cases, at least 75 mm (3 in.) must remain clear above and below the module to allow for convection cooling.

2.4.1 Backplane Mounting

The two captive M3.5 screws at the rear of the GCG001 align with mating tapped holes on the right side of the Universal Backplane (above and below the expansion connector), providing a convenient mounting location.

Note: External power must be supplied to the module—it does not draw power from the RX3i Universal Backplane.

Figure 6: Backplane Mounting



2.4.2 Panel Mounting

For applications requiring more than one GCG001 or when locating the module away from a backplane, panel-mounting is also possible. The GCG001's two captive machine screws can be used for attaching the unit to a panel.

Note: *The panel must have a minimum thickness of 2.4mm (0.094in). Leave a minimum of 75 mm (3 in.) open above and below the module to allow for ventilation and connector access.*

1. Drill two mounting holes using the spacing shown in the following drawing and tap for M3.5 screws (3.5 x 0.6 mm).
2. Align the module's two mounting screws with the mounting holes in the panel.
3. Using a Philips screwdriver, tighten the two screws to a maximum torque of 0.5 Nm (4.4 in-lbs).

2.4.3 Grounding

The GCG001 module provides a grounding connection on the power plug. The panel in which the GCG001 module or RX3i Universal Backplane is mounted to must have a safety ground connection to protective earth. This ground wire must be at least 1.5 mm² (16 AWG).

- Connect the frame ground connection on the power plug to protective earth.
- Terminate all ground wires at the same grounding point.

Figure 7: Panel Mounting

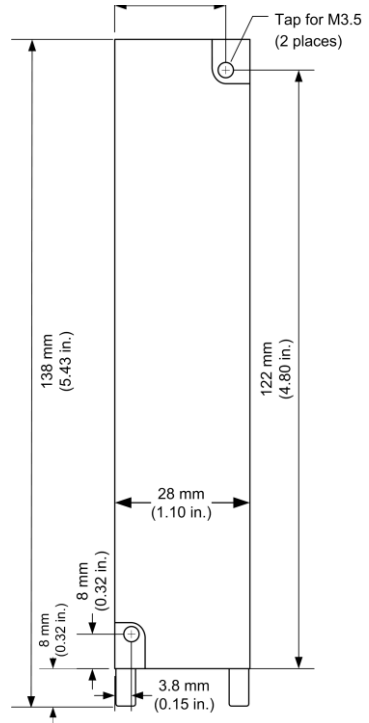

QUICK START GUIDE

GFK-2891D

Section 2

Sep 2019

- Make all ground wires as short as possible.
- Where the grounding terminal contacts a painted enclosure panel, scrape the paint away down to clean, bare metal to ensure a good contact.

3 Configuration

3.1 You Will Need:

- PACSystems RX3i CPU Firmware 8.15 or later.
- PAC Machine Edition configuration and programming software, version 8.0 or later.
- Serial or Ethernet cable for connecting the PAC Machine Edition programmer computer to the RX3i CPU.
- PACSystems RX3i PROFINET Controller (PNC) module with firmware revision 2.05 or later or a PACSystems RX3i CPE330 CPU module configured as a PROFINET Controller².
- *PACSystems RX3i Genius Communications Gateway Module User Manual*, GFK-2892, also available from the support website. You will need to refer to this manual to fully configure and commission the GCG001.

3.2 Basic Configuration Steps

The full configuration of the GCG001 is beyond the scope of this Guide, but is covered in detail in the User Manual, GFK-2892, referenced in section 10. In brief, the steps are the following:

1. If you haven't already done so, use Machine Edition to add a PROFINET IO-Controller (IC695PNC001, or PNC001) to the Target's Hardware Configuration.

² In the remainder of this guide all references to the PNC001 also apply to the CPE330 when it is configured for PROFINET.

2. Select the PNC001 in the **Navigator** window, then browse the module and the Local Area Network (LAN) configuration in the **Inspector** window, changing parameters as necessary for your system.
3. Right-click the PNC001, then select **Add IO-Device** to open the PROFINET Device Catalog dialog. Find and select the GENIUS COMMUNICATION GATEWAY, then select **OK** to add it to the I/O LAN.
4. **geniusgateway (#1)...** appears in the Device Catalog tree expanded to show **GENIUS COMMUNICATIONS GATEWAY (IC695GCG001)** below it. Select that, then **OK**.
5. **geniusgateway...** now appears as an IO device in the Hardware Configuration tree under the PNC001 with the Gateway itself appearing under it as a daughter device (see figure below).

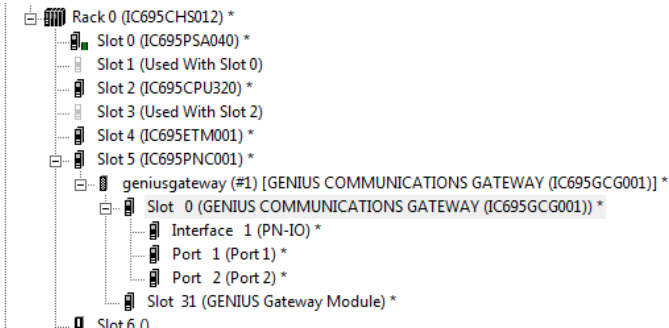
Figure 8: Configuration Steps

Note: ‘**geniusgateway**’ is the default PROFINET **Device Name** that Machine Edition gives to the first GCG001 in the Hardware Configuration under a PNC001. This **Device Name** *must match* that given to the module itself using the **PROFINET/DCP** (Discovery and Configuration Protocol) tool (see below). If there are multiple GCG001s on a PROFINET bus, each of the modules’ **Device Names** must be unique. You can change them by selecting each device in the **Navigator**, then typing in a new name in the **Inspector**.

6. Add Genius I/O devices to the Genius Bus by right-clicking **geniusgateway...** and selecting **Change Module List...** If the application is a retrofit of an existing Genius solution, be sure to set all I/O reference addresses to match those of the Genius configuration being replaced.
7. Store the Hardware Configuration to the RX3i CPU, which also stores the configuration data to the PNC001.
8. Use Machine Edition’s **PROFINET/DCP** tool to assign a name to the GCG001 so that the PROFINET Controller can connect to it and send its configuration: right-click the PNC001, then select **Launch Discovery Tool**. The tool will appear in a new **InfoViewer** tab entitled **PROFINET DCP – Direct Connection**.

Note: This tool can also be activated from the **Utilities** tab in the **Navigation** pane by selecting **Profinet DCP**. Be sure to match the name assigned in step 5, above.

9. With the GCG001 connected to the PNC001 with Ethernet cables and both the RX3i rack and the GCG001 powered up, select **Refresh Device List**. Find the GCG001 in the list. If its **Device Name** does not match the one with which the PNC001 is configured, select it, then select **Edit Device**, change the **Device Name**, then **Exit**.
10. Edit any existing ladder logic to accommodate the GCG001. Specifically, any COMREQ instructions targeted at a Genius Bus Controller must be modified to work with the GCG001.

Additional Information

PACSystems RX3i and RSTi-EP CPU Reference Manual, GFK-2222

PACSystems RX3i System Manual, GFK-2314

PACSystems RX3i PROFINET IO-Controller Manual, GFK-2571

PACSystems RX3i Genius Communications Gateway Module User Manual, GFK-2892

PACSystems RX3i Genius Communications Gateway Module Important Product Information, GFK-2900

Genius I/O System and Communications User's Manual, GEK-90486F-1

User manuals, product updates and other information sources are available on the Support website, <https://www.emerson.com/Industrial-Automation-Controls/support> under *Controllers and IO, RX3i Controllers*.

Technical Support & Contact Information:

Home link: <http://www.Emerson.com/Industrial-Automation-Controls>

Knowledge Base: <https://www.emerson.com/Industrial-Automation-Controls/support>

Note: If the product is purchased through an Authorized Channel Partner, please contact the seller directly for any support.

Emerson reserves the right to modify or improve the designs or specifications of the products mentioned in this manual at any time without notice. Emerson does not assume responsibility for the selection, use or maintenance of any product. Responsibility for proper selection, use and maintenance of any Emerson product remains solely with the purchaser.

© 2019 Emerson. All rights reserved.

Emerson Terms and Conditions of Sale are available upon request. The Emerson logo is a trademark and service mark of Emerson Electric Co. All other marks are the property of their respective owners.

