

GE Intelligent Platforms
Programmable Control Products

PACSystems* RX3i

PROFIBUS Modules

User's Manual, GFK-2301C

April 2010



Warnings, Cautions, and Notes as Used in this Publication

Warning

Warning notices are used in this publication to emphasize that hazardous voltages, currents, temperatures, or other conditions that could cause personal injury exist in this equipment or may be associated with its use.

In situations where inattention could cause either personal injury or damage to equipment, a Warning notice is used.

Caution

Caution notices are used where equipment might be damaged if care is not taken.

Note: Notes merely call attention to information that is especially significant to understanding and operating the equipment.

This document is based on information available at the time of its publication. While efforts have been made to be accurate, the information contained herein does not purport to cover all details or variations in hardware or software, nor to provide for every possible contingency in connection with installation, operation, or maintenance. Features may be described herein which are not present in all hardware and software systems. GE Intelligent Platforms assumes no obligation of notice to holders of this document with respect to changes subsequently made.

GE Intelligent Platforms makes no representation or warranty, expressed, implied, or statutory with respect to, and assumes no responsibility for the accuracy, completeness, sufficiency, or usefulness of the information contained herein. No warranties of merchantability or fitness for purpose shall apply.

* indicates a trademark of GE Intelligent Platforms, Inc. and/or its affiliates. All other trademarks are the property of their respective owners.

Contact Information

If you purchased this product through an Authorized Channel Partner, please contact the seller directly.

General Contact Information

Online technical support and GlobalCare	http://www.ge-ip.com/support
Additional information	http://www.ge-ip.com/
Solution Provider	solutionprovider.ip@ge.com

Technical Support

If you have technical problems that cannot be resolved with the information in this guide, please contact us by telephone or email, or on the web at www.ge-ip.com/support

Americas

Online Technical Support	www.ge-ip.com/support
Phone	1-800-433-2682
International Americas Direct Dial	1-780-420-2010 (if toll free 800 option is unavailable)
Technical Support Email	support.ip@ge.com
Customer Care Email	customercare.ip@ge.com
Primary language of support	English

Europe, the Middle East, and Africa

Online Technical Support	www.ge-ip.com/support
Phone	+800-1-433-2682
EMEA Direct Dial	+352-26-722-780 (if toll free 800 option is unavailable or if dialing from a mobile telephone)
Technical Support Email	support.emea.ip@ge.com
Customer Care Email	customercare.emea.ip@ge.com
Primary languages of support	English, French, German, Italian, Czech, Spanish

Asia Pacific

Online Technical Support	www.ge-ip.com/support
Phone	+86-400-820-8208
	+86-21-3217-4826 (India, Indonesia, and Pakistan)
Technical Support Email	support.cn.ip@ge.com (China)
	support.jp.ip@ge.com (Japan)
	support.in.ip@ge.com (remaining Asia customers)
Customer Care Email	customercare.apo.ip@ge.com
	customercare.cn.ip@ge.com (China)

Overview and Specifications	1-1
Finding Information in this Manual.....	1-1
Information about PROFIBUS.....	1-1
PACSystems RX3i Installation and Operation.....	1-1
PROFIBUS Master Module.....	1-2
PROFIBUS Slave Module.....	1-3
PROFIBUS Basics.....	1-4
PROFIBUS Network Overview.....	1-4
Bus Communication.....	1-4
Network Topology.....	1-5
Network Connectors.....	1-6
Data Consistency.....	1-7
Installation	2-1
Reviewing System Power Requirements.....	2-1
Installing the Module in the RX3i Backplane.....	2-2
Connecting the Module to the PROFIBUS Network.....	2-3
Network Segment Length.....	2-3
PROFIBUS Cable Types.....	2-4
Network Termination.....	2-5
Network Baud Rate.....	2-6
PROFIBUS Master Module Configuration	3-1
Adding the PROFIBUS Master Module to the Configuration.....	3-1
Configuring the PROFIBUS Master Module.....	3-2
Settings Tab.....	3-2
Using Sync/Freeze Control.....	3-4
Configuring Network Settings for PROFIBUS Master.....	3-5
Master Properties Dialog Box - General Tab.....	3-5
Master Properties Dialog Box - Network Tab.....	3-6
Master Properties Dialog Box - Parameters Tab.....	3-9
Adding Slave Devices to the PROFIBUS Master.....	3-10
Adding Slaves and Modules.....	3-10
Configuring Module Data Areas.....	3-14
Configuring DP-V1 Settings for a Slave.....	3-15
PROFIBUS Slave Configuration	4-1
Adding a PROFIBUS Slave Module to the Hardware Configuration.....	4-1
Configuring PROFIBUS Slave Parameters.....	4-2
Settings Tab.....	4-2
Input Data Area Tab.....	4-4
Output Data Area Tab.....	4-4

PROFIBUS Master Status and Diagnostics.....	5-1
PROFIBUS Master Module LEDs.....	5-2
Status Arrays	5-3
Fault Table Entries.....	5-4
PLC Faults.....	5-4
I/O Faults.....	5-4
Communication Requests.....	5-5
Get Device Status (1).....	5-6
Get Master Status (2).....	5-8
Get Device Diagnostics (4)	5-13
Read Module Header (5).....	5-14
Clear Counters (6).....	5-16
DP-V1 Read Request (7)	5-17
DP-V1 Write Request (8)	5-19
DP-V1 Alarm Acknowledge (9)	5-22
Device Information Details.....	5-24
PROFIBUS Slave Status and Diagnostics.....	6-1
PROFIBUS Slave Module LEDs.....	6-2
Status Registers.....	6-3
Slave Status	6-3
DP-V1 Status	6-3
Communication Requests.....	6-4
Get Slave Status COMMREQ (3)	6-5
Read Module Header (5).....	6-7
Clear Counters (6).....	6-9
DP-V1 Read Response (7)	6-10
DP-V1 Write Response (8).....	6-12
DP-V1 Alarm Request (9)	6-14
COMMREQ Operation	A-1
COMMREQ Ladder Instruction.....	A-2
COMMREQ Programming Requirements and Recommendations	A-3
Error Detection and Handling	A-3
Corrective Actions for COMMREQ Errors.....	A-4
COMMREQ Status Word	A-4

Chapter 1

Overview and Specifications

Finding Information in this Manual

Chapter 1, Overview and Specifications: Basic information about the PACSystems RX3i PROFIBUS Master module, IC695PBM300 and Slave module, IC695PBS301.

Chapter 2, Installation: Power requirements, cable specifications, grounding, and module installation.

Chapter 3, PROFIBUS Master Configuration: How to configure PROFIBUS master communications.

Chapter 4, PROFIBUS Slave Configuration: How to configure PROFIBUS slave communications.

Chapter 5, PROFIBUS Master Status and Diagnostics: How to use LED operation, the Slave Status bit array, the PLC fault table and communications requests (COMMREQs) to obtain status and diagnostic information.

Chapter 6, PROFIBUS Slave Status and Diagnostics: How to use LED operation, the slave Status/Firmware ID array and COMMREQs to obtain status and diagnostic information.

Appendix A, COMMREQ Operation: Operation of the Communications Request function.

Information about PROFIBUS

The PROFIBUS logo is a registered trademark of the PROFIBUS International Organization. More information about the organization and the protocol is available at <http://www.profibus.com>. Please refer to the following sources of PROFIBUS information:

- PROFIBUS standard DIN 19245 parts 1 (low-level protocol and electrical characteristics) and 3 (DP protocol)
- IEC 61158
- ET 200 Distributed I/O system, 6ES5 998-3ES22
- IEEE 518 Guide for the Installation of Electrical Equipment to Minimize Electrical Noise Input to Controllers

PACSystems RX3i Installation and Operation

PACSystems RX3i System Manual, GFK-2314
PACSystems CPU Reference Manual, GFK-2222

PROFIBUS Master Module

The RX3i PROFIBUS Master Module, IC695PBM300, allows the RX3i CPU to send and receive data on a PROFIBUS-DP network.

Features

The IC695PBM300 module provides the following PROFIBUS communications features:

- Supports all standard data rates
- Supports a maximum of 3,584 bytes of input data and 3,584 bytes of output data
- Supports a maximum of 125 PROFIBUS-DP slaves
- Supports a maximum of 244 bytes of input data and 244 bytes of output data for each slave
- Supports Sync and Freeze modes
- Supports DP-V1 Read, Write and Alarm messages
- Has PROFIBUS-compliant module and network status LEDs

Compatibility

The PROFIBUS Master module requires an RX3i CPU with firmware version 2.9 or later. This module must be located in an RX3i Universal Backplane.

The module requires Machine Edition Logic Developer-PLC, version 5.0 SP2 or later for configuration.

Firmware Upgrades

The PROFIBUS module receives its firmware upgrades indirectly from the host controller CPU using the WinLoader software utility. WinLoader is supplied with any updates to the PROFIBUS module software.

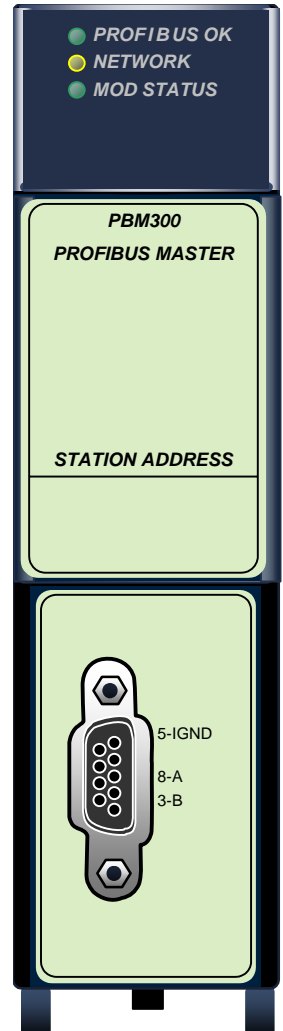

Master Module Specifications

Environment	Storage temperature = -40°C to 85°C Operating temperature = 0°C to 60°C
Backplane Compatibility	RX3i PCI
Backplane Current Consumption	440mA @ 3.3VDC
Data rates	Supports all standard data rates (9.6 kBit/s, 19.2 kBit/s, 93.75 kBit/s, 187.5 kBit/s, 500 kBit/s, 1.5 MBit/s, 3 MBit/s, 6 MBit/s and 12 MBit/s)
Status Information Available	Slave Status Bit Array Table Network Diagnostic Counters DP Master Diagnostic Counters Firmware Module Revision Slave Diagnostic Address
Data Sizes	The amount of data that can be configured on the PBM300 PROFIBUS network provides up to 3584 bytes input and 3584 bytes output.

For product standards and general specifications, refer to the *PACSystems RX3i System Manual*, GFK-2314.

PROFIBUS Slave Module

The IC695PBS301 module enables an RX3i CPU to be a slave on a PROFIBUS DP network and to communicate with a PROFIBUS DP master. The slave automatically exchanges data with a master device. The slave module has no bus access rights. It can only acknowledge received messages or transmit messages to a master upon request.

Features

The PROFIBUS Slave module provides the following PROFIBUS communications features:

- Ability to read up to 244 bytes of input data from the network, and send up to 244 bytes of output data
- Support for all standard PROFIBUS data rates
- Support for DP-V1 Read, Write and Alarm messages
- PROFIBUS-compliant module and network status LEDs

Compatibility

The PROFIBUS Slave module requires an RX3i CPU with firmware version 3.0 or later. This module must be located in an RX3i Universal Backplane.

The Slave module requires Machine Edition Logic Developer-PLC, version 5.0 Service Pack 3 or later for configuration.

Firmware Upgrades

The PROFIBUS module receives its firmware upgrades indirectly from the host controller CPU using the WinLoader software utility. WinLoader is supplied with any updates to the PROFIBUS module software.

Slave Module Specifications

Environment	Storage temperature = -40°C to 85°C Operating temperature = 0°C to 60°C
Backplane Compatibility	RX3i PCI
Backplane current consumption	440mA @ 3.3VDC
Data rates	Supports all standard data rates (9.6 KBit/s, 19.2 KBit/s, 93.75 KBit/s, 187.5 KBit/s, 500 KBit/s, 1.5 MBit/s, 3 MBit/s, 6 MBit/s and 12 MBit/s)
Status information available	Slave Status Word

For product standards and general specifications, refer to the *PACSystems RX3i System Manual*, GFK-2314.

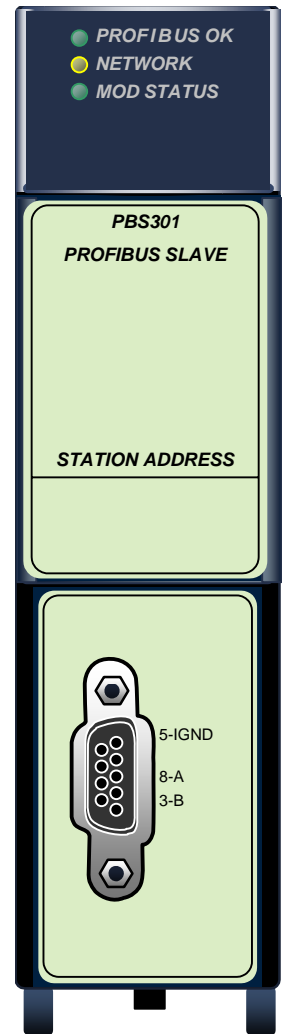

PROFIBUS Basics

PROFIBUS Network Overview

- PROFIBUS is an open, vendor independent fieldbus standard for a wide range of applications in industrial automation, including motion control.
- PROFIBUS is a dynamic technology that grows functionally while complying with IEC 61158.
- PROFIBUS Guidelines and Profiles provide the means for further technical development based on the ever-changing communication requirements of the networks, systems, and devices used in today's industrial automation applications.

The modules covered by this manual use the following protocols, which are defined by the PROFIBUS specification:

- *PROFIBUS-DP* High-speed data communication. DP stands for *Distributed Peripherals*. In practice, the majority of slave applications are DP applications.
- *PROFIBUS DP-V1* Contains enhancements for process automation, in particular acyclic data communication for parameter assignment, operation, visualization and interrupt control of intelligent field devices, parallel to cyclic user data communication.

Note: The PROFIBUS logo is a registered trademark of the PROFIBUS International Organization. Membership in the organization is open to all individuals, companies and organizations. More information about the organization and the protocol is available at <http://www.profibus.com>

Bus Communication

The PROFIBUS specification defines the technical characteristics of a serial field bus system that links distributed digital controllers on the network, from field level to cell level. PROFIBUS is a multi-master system that allows the joint operation of several automation, engineering or visualization systems with their distributed peripherals on one bus. PROFIBUS distinguishes between the following types of devices:

- **Master devices** determine the data communication on the bus. A master can send messages without an external request when it holds the bus access rights (the token). Masters are also called active stations.
- **Slave devices** include motion controllers, drives, I/O devices, valves, and transducers. Slaves do not have bus access rights and can only acknowledge received messages or send messages to the master when requested to do so. Slave devices are passive stations and require only small portions of the bus protocol.

The majority of PROFIBUS-DP applications are located at the field level. The field level typically includes slave devices such as the S2K motion controller station and host devices such as PLC or PC control systems for the PROFIBUS-DP master station. Operator interfaces and DCS type systems usually operate at the cell level.

Data Bandwidth Demands on PROFIBUS Communications Systems

	Amount of Data	Transmission Duration	Transmission Frequency
Management level	MBytes	Hours/Minutes	Day/Shift
Cell level	KBytes	Seconds	Hours/Minutes
Field Level	Bytes	Several 100 microseconds to 100 milliseconds	10 to 100 Milliseconds
Actuator sensor level	Bits	Microseconds to milliseconds	Milliseconds

Network Topology

PROFIBUS uses linear bus architecture with active bus termination at both ends. Devices in a PROFIBUS network connect directly to the bus cable or indirectly via stub lines.

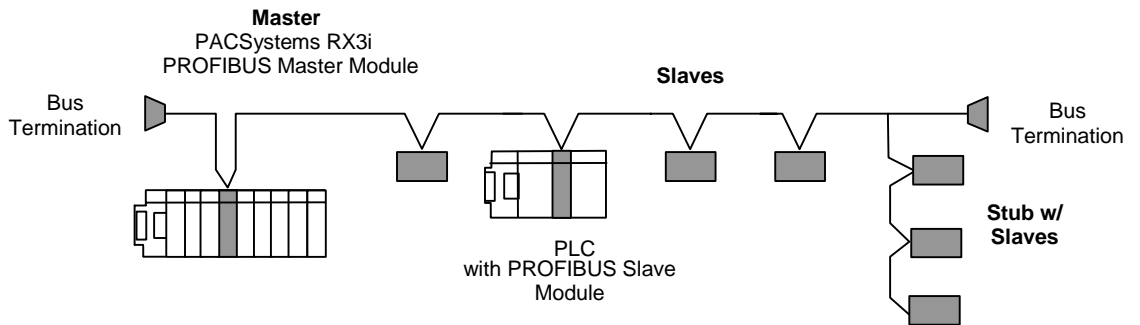

Sample PROFIBUS Network

A PROFIBUS-DP network may have up to 125 slave stations (addresses 0-126 are valid addresses), however address 126 is reserved for commissioning purposes. The master must consume one of the valid addresses to create a PROFIBUS system. The bus system must be sub-divided into individual segments to handle this many participants. These segments are linked by repeaters, which condition the serial signal to allow connection of segments. In practice, both regenerating and non-regenerating repeaters may be used. Regenerating repeaters condition the signal to allow increased range of the bus. *Up to 32 stations are allowed per segment and the repeater counts as a station address.*

A specialized "link" segment consisting only of optical fiber modem repeaters may be used to span long distances. Plastic fiber optic segments are typically 50 meters or less while glass fiber; optic segments may extend several kilometers.

The user assigns a unique PROFIBUS station address to identify each master, slave, or repeater in the network. Each participant on the bus must have a unique station address.

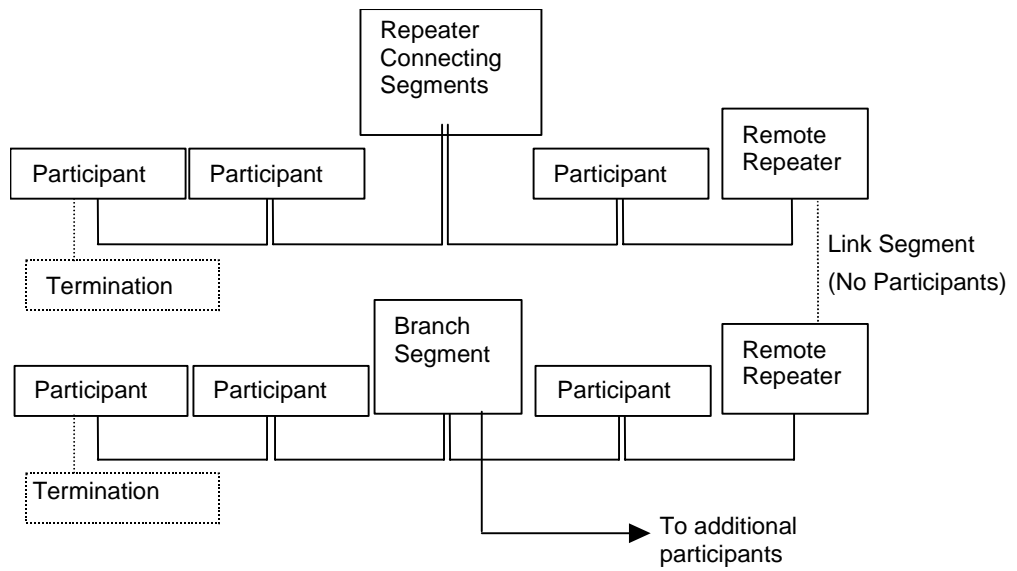

Repeaters and Bus Termination

Network Connectors

PROFIBUS connections are typically created with a 9-pin sub-D connector. A minimum connection consists of a shielded twisted-pair cable (shield to pin 1 and twisted-pair wires to pins 3 and 8) with terminating connections in the appropriate bus plugs. The pin to signal conventions for a 9-pin sub-D connector are described below.

PROFIBUS Bus Connector Pin Assignments

Pin No.	Signal	Designation
1	Shield	Shield / protective ground
2	M24	-24V Output voltage
3	RxD/TxD-P	Receive data / transmission data positive
4	CNTR-P	Control signal for repeaters (direction control)
5	DGND	Data ground
6	VP	Supply voltage of the terminating resistance (+ 5V)
7	P24	+24V Output voltage
8	RxD/TxD-N	Receive data / transmission data negative
9	CNTR-N	Control signal for repeaters (direction control)

Note: For information on network segment length, network connectors and network termination, and network baud rate, refer to Chapter 2, "Installation."

Data Consistency

Data consistency ensures that a data block contains one set of updated data instead of a mixture of old and new data. In systems that provide data consistency, the master is prevented from reading or writing the slave data while the slave is updating its data area. For consistent data exchanges between any PROFIBUS master and any PROFIBUS slave, both master and slave must support consistency.

- All GE PROFIBUS masters provide data consistency when used with a slave station that has data consistency.
- All PROFIBUS devices provide byte and word-level consistency.
- Some devices support *whole length* data consistency, meaning that all words are guaranteed to be consistent over one network scan.

Whether a slave supports whole length data consistency is determined on a module-by-module basis, as specified in the GSD (General Station Description) file associated with the slave. For each supported module type, the GSD file contains a *configuration identifier* that specifies module characteristics, such as data length and consistency.

The following GE slave device supports whole length data consistency for some modules: IC220PBI002

To find out whether a module supports whole length consistency, examine the configuration identifier. For explanation of the configuration identifier formats, refer to the *PROFIBUS Specification*.

Sample Configuration Identifiers:

```
General identifier format  Module = "16 byte input  (0x1F)" 0x1F
(identifier byte)        8
                          EndModule

Special identifier format  Module = "16 word output  (0x6F)" 0x6F
                          38
                          EndModule
```

To determine whether non-GE PROFIBUS modules support consistency, refer to the documentation provided by the module manufacturer.

Chapter 2

Installation

This chapter contains information on the following procedures:

- Reviewing system power requirements
- Installing the PROFIBUS module in the host controller rack
- Installing PROFIBUS wiring
 - Connecting the module to the PROFIBUS network
 - Selecting the proper line type
 - PROFIBUS cable types
 - Installing bus termination

Reviewing System Power Requirements

Review the power requirements of your system to ensure that your power supply has sufficient capacity to support the PROFIBUS module. The Machine Edition software automatically calculates power supply load. Details on manually calculating power supply load can be found in the *PACSystems RX3i System Manual*, GFK-2314.

Master Module (PBM300) 440mA at 3.3VDC (typical)

Slave Module (PBS301) 440 mA at 3.3 VDC (typical)

Installing the Module in the RX3i Backplane

The PROFIBUS module must be located in an RX3i Universal Backplane (IC695CHS012 or CHS016). It cannot be located in an expansion or remote backplane.

Modules in a Universal Backplane (IC695CHS012 or CHS016) can be installed or removed while power is applied to the system. This includes backplane power and field power supplied to the module.

Note: The module must be properly seated on the carrier with the latch engaged and all pins connected within 2 seconds. For removal, the module must be completely disengaged from the carrier within 2 seconds. It is important that the module not remain partially inserted during the insertion or removal process. There must be a minimum of two seconds between the removal and insertion of modules.

Warning

Inserting or removing a module with power applied to the system may cause an electrical arc. This can result in unexpected and potentially dangerous action by field devices. Arcing is an explosion risk in hazardous locations. Be sure that the area is non-hazardous or remove system power before removing or inserting a module.

For details about installing RX3i rack systems and modules, refer to the *PACSystems RX3i System Manual*, GFK-2314.

Connecting the Module to the PROFIBUS Network

The module contains a standard female DB9 connector, labeled "PROFIBUS," that can be connected to a PROFIBUS bus terminal that complies with EN 50170.

The PROFIBUS module has no built-in termination. If termination is required, you must use a bus terminal that has built-in selectable termination.

- PROFIBUS DB-9 connector recommendation: Siemens 6ES7-972-OBB50-OXAO (12MB)

Caution

Do not connect any devices to the +5V pin (pin 6). It is to be used for termination purposes only. Doing so could damage equipment or cause erratic behavior.

Network Segment Length

A PROFIBUS network uses either fiber optic or RS-485 copper media. The copper bus line specified in EN 50170 is "Line Type A" and is the recommended cable type. Cable Type B should not be used with this product. It is extremely important to use cable rated to PROFIBUS specifications. The higher the baud rate selected and the longer the distances involved, the more critical cable selection becomes. (PROFIBUS cable has a distinctive purple color.) For details, see "PROFIBUS Cable Types" on page 2-4.

Stub or "T" type branch connections are supported if the total stub (branch) lengths do not exceed 6.6 meters. Do not use stubs at all on 12 MBaud networks.

The data rates for network communication with maximum segment trunk length for type A cable are provided in the following table. Multiple segments may be connected via repeater stations to extend the total bus length.

Data Rates and Segment Lengths for Cable Type A

Baud Rate	Distance (Max) *	Glass Fiber
9.6 Kbit/s, 19.2 Kbit/s and 93.75Kbit/s	1200 m	6 km
187.5 Kbit/s	1000 m	6 km
500 Kbit/s	400 m	6 km
1.5 MBit/s	200 m	6 km
3 MBit/s, 6 MBit/s and 12 MBit/s	100 m	6 km

* Values shown are the sum of all bus segments and drop cable lengths.

NA = Not Applicable

PROFIBUS Cable Types

The recommended cable is:

- Belden 3079A PROFIBUS cable

This is a shielded, 150 Ohms twin-axial (single twisted pair) cable. It has 0.66 mm conductor diameter and a mutual capacitance of 28 pF/m, nominal. For complete specifications on this cable, please contact your Belden dealer or visit their website at www.belden.com.

Alternate cable types are:

- Siemens 6XV1 830-OAH10 Two Core shielded
- Siemens 6XV1 830-OBH10 w/PE Sheath
- Siemens 6XV1 830-3AH10 for underground burial
- Siemens 6XV1 830-3BH10 trailing cable
- Bosch Comnet DP #913 548 Flexible PROFIBUS cable
- Bosch Comnet DP #917 201 Trailing PROFIBUS Cable
- Bosch Comnet DP #917 202 Massive PROFIBUS Cable

Notes: Allen Bradley “blue hose”, which has an impedance of 78 Ohms, is **not** recommended for this application.

Cable type B should not be used with the PROFIBUS module.

Type A Cable Specifications

Impedance	135 to 165 Ohms at f = 3 to 20 MHz
Capacitance	< 30 pF/m
Resistance	< 110 Ohms/km
Core Diameter	> 0.64 mm
Conductor Area	> 0.34 mm ² (22 AWG)

Network Termination

Termination Note: The two physical ends of the PROFIBUS network must be terminated. There should be two, and only two, terminators on a network.

Termination resistors are needed, as defined in DIN 19245 Part 1 section 3.1.2.5.

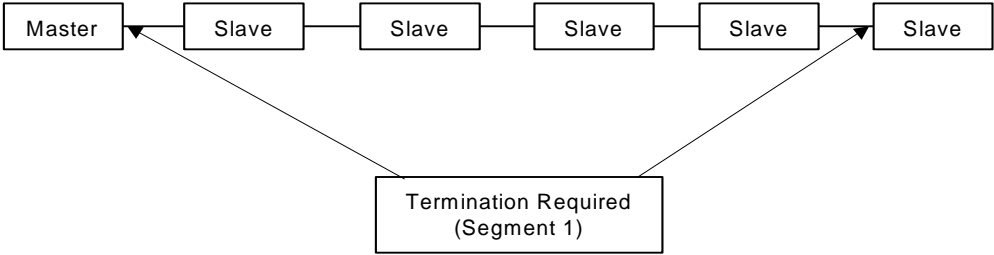

One terminator must be applied at each end of a network segment.

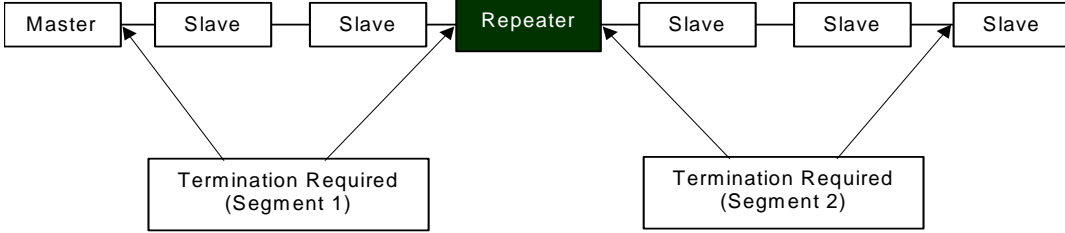

Generally, termination is provided in commercially-available PROFIBUS standard network connectors. Some connector vendors provide termination capability in the connector and a switch on the connector to enable/disable termination. Some connector vendors provide both terminated and unterminated connectors.

Note: For proper network termination, it is essential that the terminating devices maintain power. Power is provided by the device on Pin 6 and Ground on Pin 5. If power is lost to either terminating device, the network may not operate correctly. Generally, the lone network master device is one of the terminating devices. Therefore, a loss of power to the network master renders the network inoperable anyway. The other terminating device may be a critical slave device that must maintain power or a separately powered, stand-alone terminator. These stand-alone devices are commercially available.

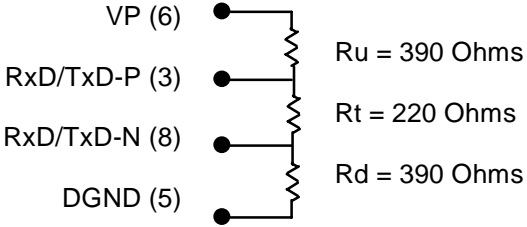

Bus Termination for Type A Cable in Accordance to PROFIBUS Specifications

In addition to the termination shown above, the following compensation should be added for 12 Mbit/s bus technology:

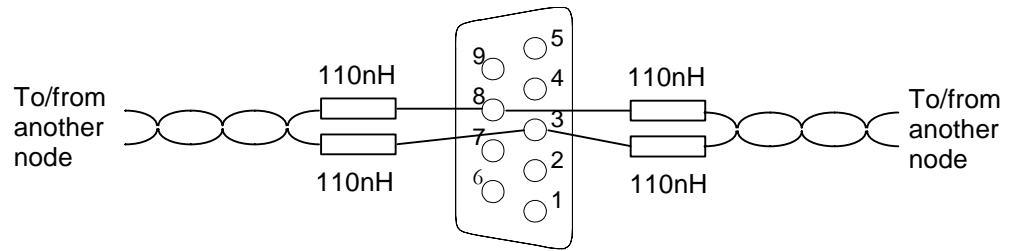

12 Mbit/s Bus Compensation

Network Baud Rate

The master configures the appropriate network baud rate for each station on the network. Typical baud rate values are: 9.6 Kbit/s, 19.2 Kbit/s, 93.75 Kbit/s, 187.5 Kbit/s, 500 Kbit/s, 1.5 Mbit/s, 3 Mbit/s, 6 Mbit/s, or 12 Mbit/s. For details on using the configuration software, refer to chapter 3.

Chapter 3

PROFIBUS Master Module Configuration

These configuration procedures are written for users with at least a basic knowledge of the Machine Edition Logic Developer software and the PACSystems RX3i. For help with using the software, please see the software's built-in help system.



Note: The PROFIBUS Master module does not support redundant masters.

Software configuration of the PROFIBUS master module consists of the following steps:

- Adding the PROFIBUS master module to the configuration
- Configuring the PROFIBUS master parameters
- Configuring network settings for the PROFIBUS master
- Adding slave devices to the PROFIBUS master configuration

Adding the PROFIBUS Master Module to the Configuration

Add the IC695PBM300 module to the rack configuration.

1. In the  Project tab of the Navigator,  expand the  Hardware Configuration folder.
2. In the Hardware Configuration folder, expand the main rack, right click the slot where the module will reside and select Add Module. The Module Catalog dialog box appears.
3. Select the IC695PBM300 PROFIBUS Master module and click the OK button. The module is added to the configuration in the Navigator window, and the module's Parameter Editor window appears.

Configuring the PROFIBUS Master Module

The parameters on the Settings tab are used to configure the operation of the PROFIBUS master.

Settings Tab

<p>Slave Status Bit Array Address</p>	<p>The starting address for the consumed range used to receive the slave status bits. This array of bits indicates the health of each node on the PROFIBUS network. The Slave Status Bit Array must be a non-overlapping range in %AI, %I, %Q, %G, %AQ, %R, %W, %T, or %M. It defaults to %I memory.</p> <p>A slave's status address equals Start Address + Station Address of the slave. For example, if the status bits are mapped to %I00001, the status for the slave at Station Address 5 would be found at %I00001 + 5=%I00006.</p> <p>The master's status is located in the same way as the slaves' (Start Address + Station Address). The master is configured as station 0 by default, but can be set to any valid address (0-125). For information on changing the master's station address, see "Configuring Network Settings for PROFIBUS Master" on page 3-5.</p> <p>Tip:</p> <ul style="list-style-type: none"> ■ Use the Communication Request command 1 (Get Device Status) or command 2 (Get Master Status) to retrieve the status information that is reported in this memory area. For details, see "Communication Requests" in chapter 4.
<p>Length (of slave status bit array)</p>	<p>For discrete memory, Length is 128 bits. For word-type memory, Length is 8 words.</p>
<p>Slave Diagnostics ID Address</p>	<p>The starting address for this 32 bit (two-word) consumed array. The Slave Diagnostics ID array requires a non-overlapping range in %AI, %I, %Q, %G, %AQ, %R, %W, %T, or %M. Defaults to %AI memory.</p> <ul style="list-style-type: none"> ■ The first word (Slave Diagnostics) is used by the PROFIBUS master to communicate the station address of any slave that has reported diagnostic data. If diagnostics are pending, the master places the address of the first slave that has diagnostics into this word. The diagnostics can be read using the Get Device Diagnostics COMMREQ (command 4). This clears the word and the master then places the next pending diagnostic address into the Slave Diagnostics word. If the word is zero there are no pending diagnostics. ■ The second word is set to a value of 0.
<p>Length (of slave diagnostics ID array)</p>	<p>For discrete memory, Length is 32 bits. For word-type memory, Length is 2 words.</p>
<p>Sync/Freeze Control Bits Address</p>	<p>The starting reference address of a 16-bit (1-word) produced range used for the Sync/Freeze command data. The Sync/Freeze Control Bits must be in a non-overlapping range in %AI, %I, %Q, %G, %AQ, %R, %W, %T, or %M. Defaults to %Q memory.</p> <p>Sync and Freeze are global control functions used to synchronize remote I/O stations. You can use these functions to cause a group of slaves to operate at the same time in your system. For additional information, see "Using Sync/Freeze Control" on page 3-4.</p>
<p>Length (of sync/freeze control bits)</p>	<p>For discrete memory, Length is 16 bits. For word-type memory, Length is 1.</p>

DPV1 Status	<p>The starting reference address of a 32-bit (2-word) produced range used at the beginning of a scan to receive the station address of a slave that has sent a DPV1 Alarm message. If another slave has sent a DPV1 alarm message, it is ignored until the first one has been serviced, and will then appear in a subsequent scan.</p> <p>To acknowledge the DPV1 Alarm message and obtain the alarm information it contains, use a DPV1 Alarm Acknowledge (command 9) COMMREQ.</p> <p>The DPV1 Acknowledge block must be a non overlapping range in %AI, %I, %Q, %G, %AQ, %R, %W, %T, or %M. Defaults to %AI memory. For the block format, see “DPV1 Alarm Acknowledge” in chapter 4.</p>
Length (of DPV1 Alarm Status Block)	The length for the DPV1 Alarm Status Block is always 2 words (32 bits).
Slave Configured Bits	<p>The starting address for the consumed range used to receive the array of bits that indicate which slaves on the PROFIBUS network are configured. The array contains 128 bits (8 words). The Slave Configured Bits array must be a non-overlapping range in %AI, %I, %Q, %G, %AQ, %R, %W, %T, or %M. It defaults to %I memory.</p> <p>Each slave has a corresponding bit in this array. A slave's configuration status address equals Start Address + Station Address of the slave. For example, if the configuration status bits are mapped to %I00001, the status for the slave at Station Address 5 would be found at %I00001 + 5=%I00006.</p>
Length	If Length is set to 0 (default), the Slave Configured Bits mapping is disabled. If Length is set to 128, mapping is enabled.
Slave Diagnostic Bits	<p>The starting address for the consumed range used to receive the array of bits that indicate which slaves on the PROFIBUS network have diagnostic data available. The array contains 128 bits (8 words). The Slave Diagnostics Bits array must be a non-overlapping range in %AI, %I, %Q, %G, %AQ, %R, %W, %T, or %M. It defaults to %I memory.</p> <p>The diagnostics can be read using the Get Device Diagnostics COMMREQ (command 4).</p> <p>Each slave has a corresponding bit in this array. A slave's diagnostic status address equals Start Address + Station Address of the slave. For example, if the configuration status bits are mapped to %I00001, the status for the slave at Station Address 5 would be found at %I00001 + 5=%I00006.</p>
Length	If Length is set to 0 (default), the Slave Diagnostics Bits mapping is disabled. If Length is set to 128, mapping is enabled.
Network Settings	Double-clicking this field opens the Master Properties dialog box. This dialog box is discussed in “Configuring Network Settings.”
Inputs Default	<p>Determines the values that the master reports for a particular slave if communications between master and slave are lost. The RX3i CPU applies this setting in any case where the PROFIBUS Master module is no longer available.</p> <p>Choices are Hold Last State (default) and Force Off.</p>
Slave Status Fault Table Entries	If set to True (default), slave communications status events (loss and re-establish) are reported as fault table entries. If set to False, slave status events are not reported to the fault table.
Download Names/Descriptions	If set to True, names and descriptions for the slaves and the master are sent to the PLC and do not revert to default upon uploading. If set to False, the names and descriptions are not downloaded to the PLC and revert to the default values upon uploading from the PLC.
Note:	Downloading names and descriptions uses more memory in the PLC. It is recommended that this parameter remain set to False (Default). Names and descriptions are a convenience only. Omitting them from the download does not affect system operation.
I/O Scan Set	The scan set (as defined in the CPU's Scan Sets tab) to be assigned to the PROFIBUS module.

Using Sync/Freeze Control

Sync and Freeze are global control functions used to synchronize remote I/O stations. You can use these functions to cause a group of slaves to operate at the same time in your system.

- The Sync command is used to control a slave's outputs. When a slave receives a Sync command, it holds the last output data from the master until the slave receives another sync command from the master.
- Freeze is used to control a slave's inputs. When a Freeze command is sent to a slave, the slave freezes its current inputs and does not update the inputs with new data until it receives another Freeze command.

The use of the Sync/Freeze control word is optional. However, it must be assigned a starting reference address, which is defined in the PROFIBUS configuration parameters. The Sync/Freeze control word can be assigned to any PLC memory area and has a length of either 16 bits if in discrete PLC memory (%Q, %I, %T, %M, %G) or one word if in Word PLC memory (%AI, &AQ, %R, %W). The default is the first available address in %Q.

To use the Sync/Freeze control, you must specify a Group Select and a Command.

Sync/Freeze Control Word

Bits	Name	Description
0—7 (LSB)	Group Select	Specifies which group of slaves to send this command to. Each slave can be in one or more groups (0 through 7), which are selected on the Parameters tab of the slave Properties dialog box. The Group ID is a bit mask of the Group ID locations. The LSB corresponds to Group ID 0 and the MSB corresponds to Group ID 7.
8—15 (MSB)	Command	The command can be one of the following (HEX): UNFREEZE = 0x04 FREEZE = 0x08 UNSYNC = 0x10 SYNC = 0x20 TRIGGER = 0x80* * The most significant bit is used to trigger the command to be sent.

Note: The trigger operation occurs on both the 0 to 1 and 1 to 0 transitions of the Trigger bit.

Example

If you wanted to send a SYNC command to all the slaves with group ID 04, you would write 0x10 to the LSB (which sets bit 4 of the Group Select byte) and 0x20 to the MSB.

To send this command, toggle the trigger bit of the Command (bit 15).

Configuring Network Settings for PROFIBUS Master

To configure network settings for the master, double-click the Network Settings field in the Parameter Editor Settings tab. The Master Properties dialog box opens.

Note: You can also open this dialog box by selecting the Project tab of the Navigator and expanding the Hardware configuration folder and the rack that contains the module. Right click the slot containing the IC695PBM300 module, and choose Network Settings.

Master Properties Dialog Box - General Tab

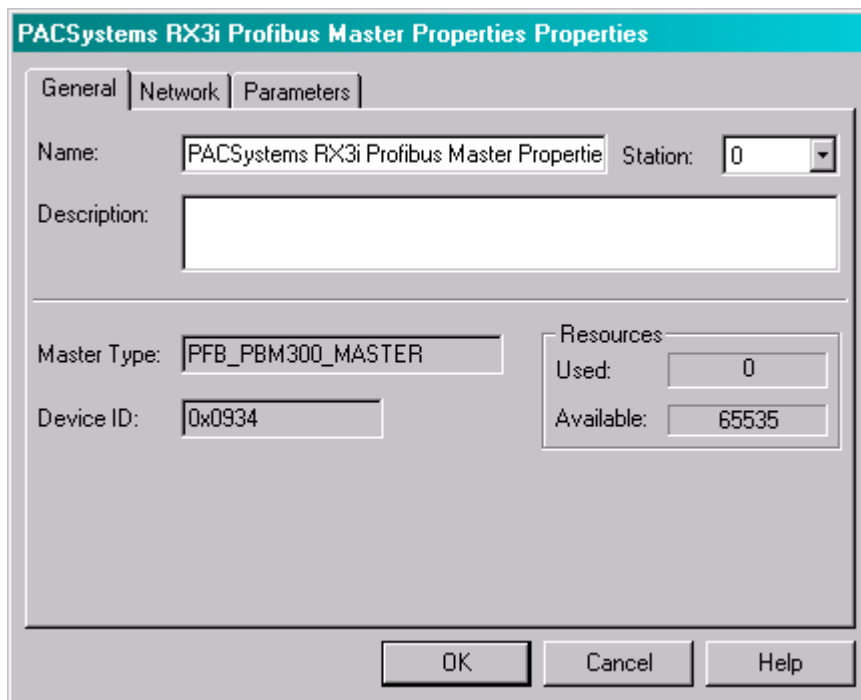

Name	The name assigned to the PROFIBUS master. You can edit the name or use the default name. The name appears in the title bar of the dialog box.
Station	The address of the PROFIBUS master on a PROFIBUS DP network. The master is configured as Station 0 by default. Each device on a network must have a unique address. Note: If the network is operating at 9.6 Kbits/s, the master must be configured with an address of 59 or less.
Description	An optional user-defined description for the PROFIBUS master device, which is displayed in the Machine Edition software's Inspector window. The Inspector displays a maximum of 254 characters. However, more than 254 characters can be entered in the dialog box.
Master Type	The type of PROFIBUS master device. This is a read-only field.
Device ID	The ID of the PROFIBUS master device. This is a read-only field.
Resources - Used	The number of bytes used by the PROFIBUS master device. The amount of resources used depends on the PROFIBUS slave(s) that are configured and each slave's modules, parameters, and diagnostic messages. This is a read-only field.
Resources - Available	The number of bytes available for use by the PROFIBUS master device. The amount of available resources depends on the PROFIBUS slave(s) that are configured and each slave's modules, parameters, and diagnostic messages. This is a read-only field.

Master Properties Dialog Box - Network Tab

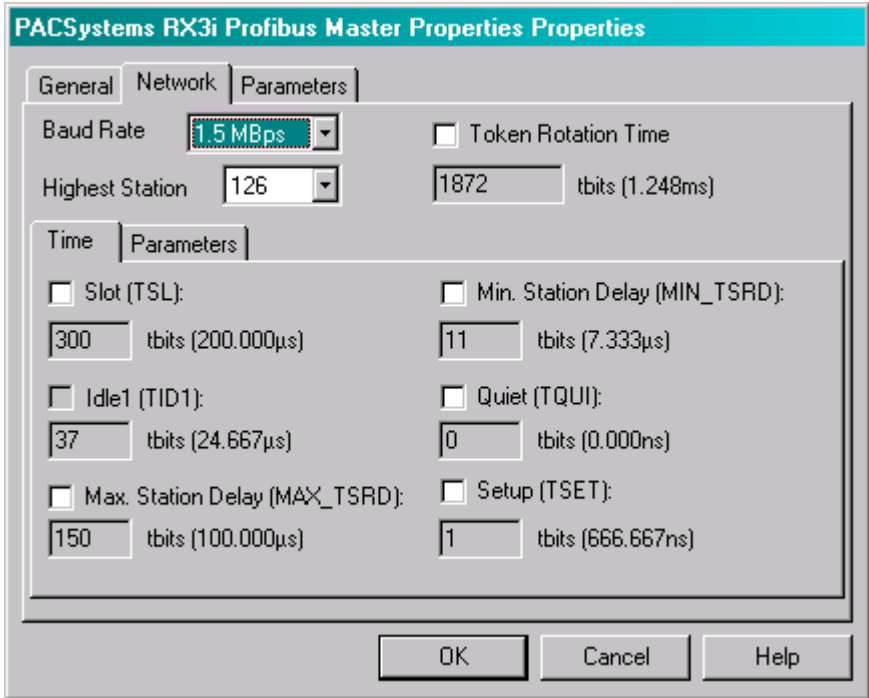

Network parameters are automatically set. This tab provides additional configuration for advanced users.

Baud rate	The baud rate of the PROFIBUS network. The choices are 9.6 KBps, 19.2 KBps, 93.75 KBps, 187.5 KBps, 500 KBps, 1.5 MBps, 3 MBps, 6 MBps, 12 MBps. Default is 1.5 MBps.
Highest Station	The highest possible station address for any active station on the network. This affects how much time is spent soliciting for new PROFIBUS master devices. Default is 126.
Token Rotation Time	The maximum target token rotation time for the network, expressed in t_bits and seconds. (A t_bit (<i>time bit</i>) is the inverse of the baud rate.) Valid range: 0 through 20,971,200 t_bits

Time Sub-Tab of Network Tab

Time	Parameters
<input type="checkbox"/> Slot (TSL):	<input type="checkbox"/> Min. Station Delay (MIN_TSRD):
<input type="text" value="300"/> tbits (200.000µs)	<input type="text" value="11"/> tbits (7.333µs)
<input type="checkbox"/> Idle1 (TID1):	<input type="checkbox"/> Quiet (TQUI):
<input type="text" value="37"/> tbits (24.667µs)	<input type="text" value="0"/> tbits (0.000ns)
<input type="checkbox"/> Max. Station Delay (MAX_TSRD):	<input type="checkbox"/> Setup (TSET):
<input type="text" value="150"/> tbits (100.000µs)	<input type="text" value="1"/> tbits (666.667ns)

Slot (TSL)	The amount of time (in t_bits and seconds) the PROFIBUS master waits for a reply to a message. Valid range: 0 through 65,535 t_bits. Default depends on the Baud Rate and other parameters on the Time and Parameters subtabs.
Idle1 (TID1)	Read only. The amount of time (in t_bits and microseconds) the PROFIBUS master waits after it receives a reply or an acknowledgement.
Max. Station Delay (MAX_TSRD)	The amount of time (in t_bits and seconds) the PROFIBUS master waits after sending a message and before sending another message. Valid range: 0 through 65,535 t_bits. Default depends on the Baud Rate, Quiet (TQUI) and Setup (TSET) parameters.
Min. Station Delay (MIN_TSRD)	The amount of time (in t_bits and seconds) the PROFIBUS master waits before sending an ACK response after sending a command. Valid range: 0 through 65,535 t_bits. Default: 11 t_bits.
Quiet	The amount of time (in t_bits and nanoseconds) the PROFIBUS master waits after it turns on its transmitter before it begins to send data. Valid range: 0 to 255 t_bits. Default depends on Baud Rate.
Setup (TSET)	The time that expires from the occurrence of a transmission event (for example, an interrupt on the last bit of a sent telegram or when synchronization time expires) until the necessary reaction is performed (for example, to start synchronization time or to enable the receiver). The time is expressed in t_bits and seconds. Valid range: 1 through 255. Default: Depends on Baud Rate.

Parameters Sub-Tab of Network Tab

Time	Parameters		
<input type="checkbox"/> Token Retry:	N/A	<input type="checkbox"/> Gap Update Factor:	10
<input type="checkbox"/> Token Error:	N/A	<input type="checkbox"/> Message Retry:	1
<input type="checkbox"/> Response Error:	N/A		

Token Retry	Not supported. Read only.
Token Error	Not supported. Read only.
Response Error	Not supported. Read only.
Gap Update Factor	The number of token rotations between solicitations for a new PROFIBUS master card. Valid range: 0 to 255. Default: 10
Message Retry	The maximum number of times the PROFIBUS master tries to send a message when the slot time expires. Valid range: 0 to 255. Default depends on Baud Rate.

Master Properties Dialog Box - Parameters Tab

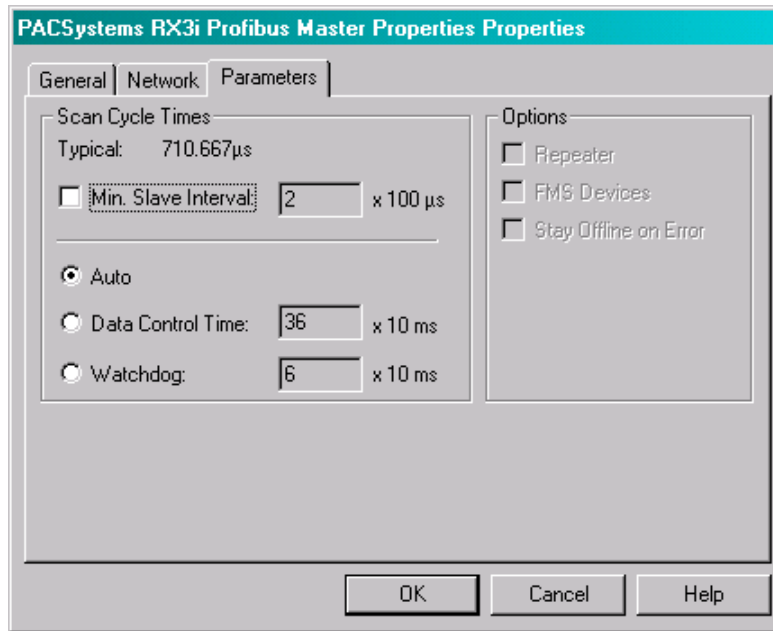

Scan Cycle Times	
Typical	The estimated time (µs) required for one scan of the PROFIBUS network. This is a read-only field. The following parameters enable you to set minimum and maximum scan cycle times for the Watchdog timer
Min. Slave Interval	The minimum I/O scan time in 100 microsecond increments. This may be required if the I/O modules are restricted in how often they can be scanned. Valid range: 2 to 65535. Default: 2
Auto	The maximum I/O scan time and Watchdog timer are assigned automatically based on the number of slave devices configured.
Data Control Time	The maximum I/O scan time in 10 millisecond increments. If the scan time exceeds this value, the PROFIBUS master faults all the slaves, reinitializes them, and brings them back online. When the maximum I/O scan time is updated, the Watchdog timer is also updated. Range is 12 to 65535. Default: 6 * W, where W = the value assigned to the Watchdog parameter
Watchdog	If a PROFIBUS slave does not receive any communication from its master within the Watchdog time, the slave generates a fault, the outputs are set to 0, and the slave is reinitialized by the PROFIBUS master card. Assigning a value affects the maximum cycle time. Valid range: 2 through 10,922, where each unit represents a 10 millisecond increment. For example, a value of 3 represents 30 milliseconds. Default: DCTM / 6, where DCTM = the value assigned to the Data Control Time parameter
Options Parameter Group	
Repeater	Not supported. Read only.
FMS Devices	Not supported. Read only.
Stay Offline on Error	Not supported. Read only.

Adding Slave Devices to the PROFIBUS Master

The number and types of slave devices that can exchange data with the master are constrained by memory resources within the master module. The amount of memory available for the PROFIBUS configuration is affected by the number and types of slave modules in the network configuration. The total slave configuration data size is limited to approximately 9KB.

Adding Slaves and Modules

1. In the Navigator window, right click the IC695PBM300 and choose Add Slave. The Slave Catalog dialog box appears. This dialog box lists the slave devices that are available to configure in the PROFIBUS network.

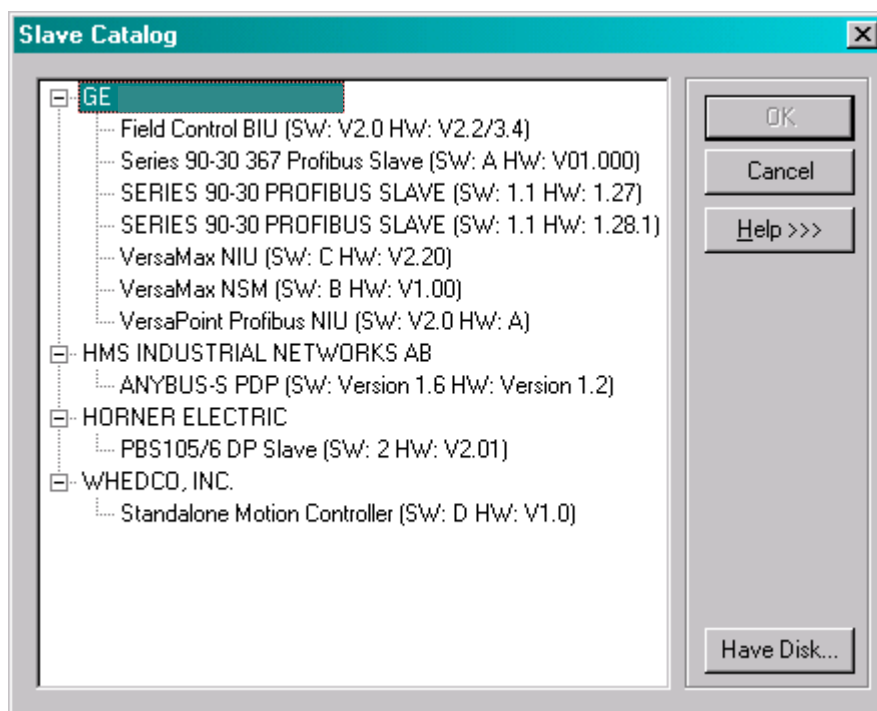

2. Select a slave device and click OK. The Slave Properties dialog box opens.

Note: If the slave module is not in the list but you have a GSD file for it, click the “Have Disk” button.

Note: The following figures use the IC693PBS201 PROFIBUS Slave module as an example.

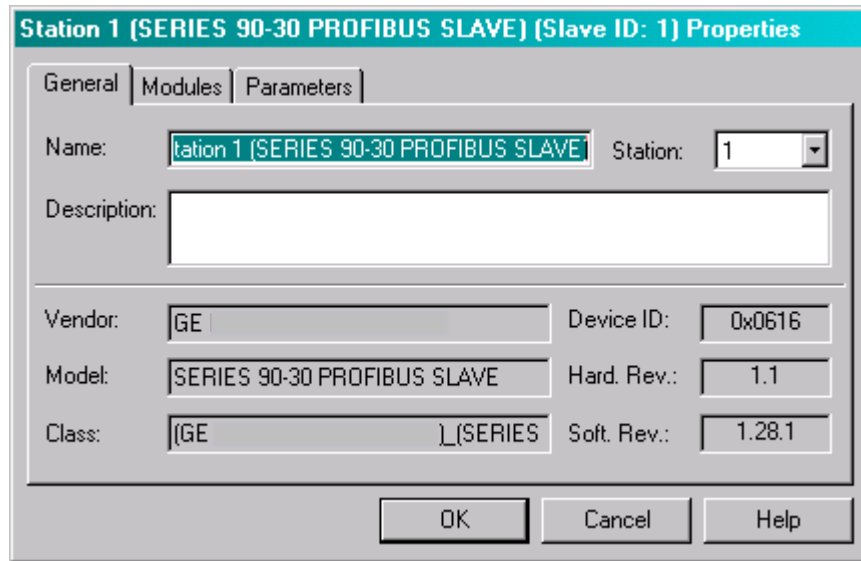

Name	The name assigned to the slave. You can edit the name or use the default name. The name appears in the title bar of the dialog box (in the figure above, the default name is Station 1 (SERIES 90-30 PROFIBUS SLAVE)).
Station	The address of the slave on a PROFIBUS DP network. The slave is defaulted to the next highest available address.
Description	An optional description for the slave device. The Inspector displays a maximum of 254 characters. However, more than 254 characters can be entered in the dialog box.
Vendor	The manufacturer of the slave device, from the GSD file. This is a read-only field.
Device ID	The ID of the PROFIBUS device. This is a read-only field.
Model	The model of the slave device. This is a read-only field.
Hardware Rev.	The hardware revision of the device, from the GSD file. This is a read-only field.
Class	The class of the slave device. This is a read-only field.
Software Rev.	The software revision of the device, from the GSD file. This is a read-only field.

3. Enter “Name”, “Description” and “Station” if desired.

- 4. To add modules to the slave, select the Modules tab and click Add. The Select New Module dialog box appears.

Note: To add the slave to the configuration, you must configure at least one module.

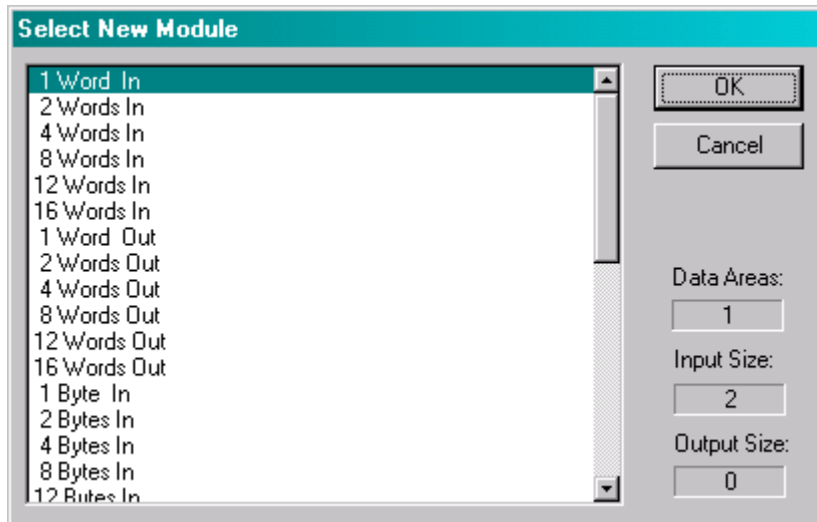

Note: The Select New Module list of modules is determined by the .GS* for the slave type. Each type of slave may have a different list of modules.

- 5. Select a module and click OK. The module is added to the Modules list in the slave Properties dialog box. Add additional modules as required for your system. The following figure shows the Modules tab after several modules have been added.

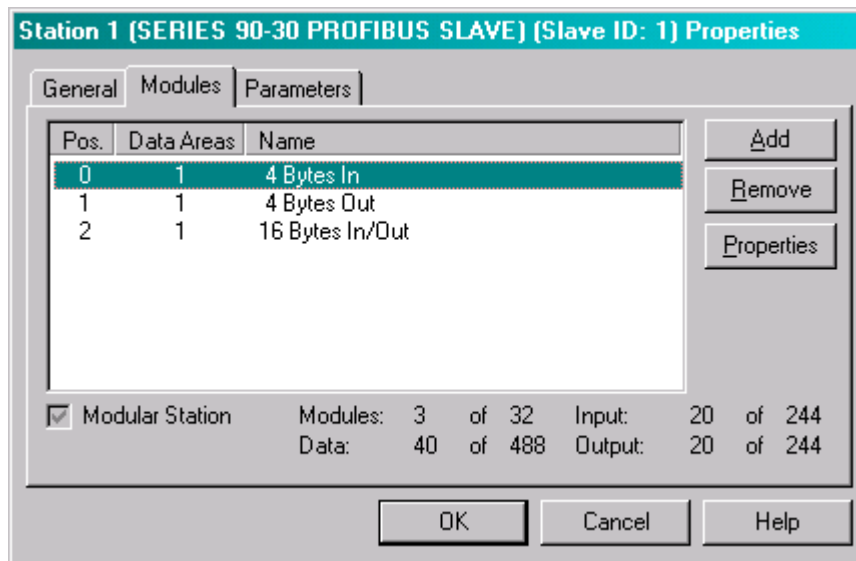

To change the order (position) of a module, select it and click Properties. The module Properties dialog box opens. Enter the numerical value of the new position the module is to have. The position numbering starts at 0.

The other information in this dialog box is generated by the GSD file associated with the Slave module.

Note: The Data field corresponds to the module's configuration identifier as defined in the PROFIBUS specification.

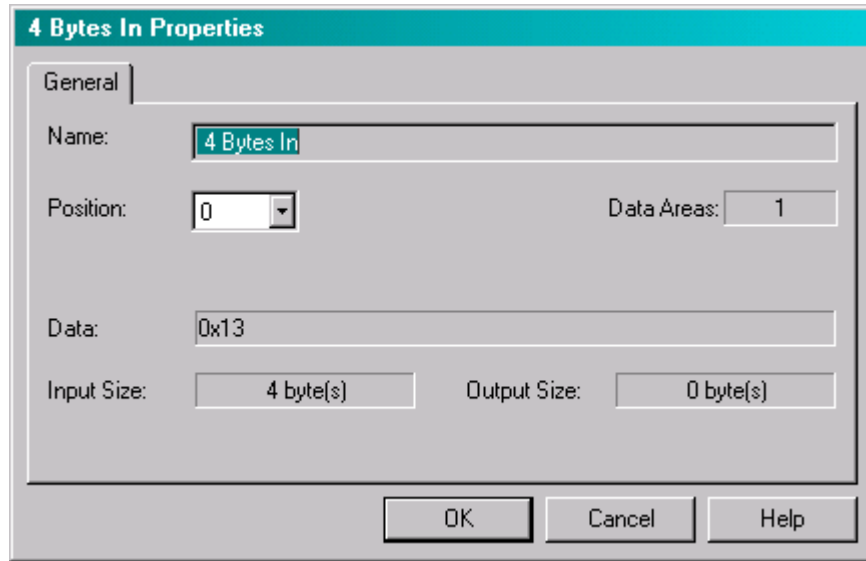

- 6. When you have finished adding modules, click OK. The modules appear under the slave node in the Hardware Configuration.

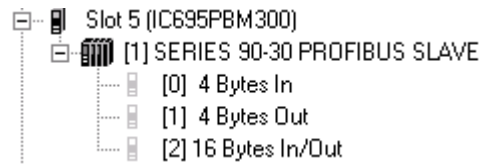

Note: To add, remove, or change the order of modules associated with an existing slave, right click the Slave node in the Hardware Configuration and choose Configure. The Properties dialog box for the selected slave opens. (See page 3-11.)

Configuring Module Data Areas

To configure module data areas, right click the module node in the Hardware Configuration, and choose Configure. The Parameter Editor window for the module appears.

The values for read-only parameters are supplied from the GS* text file that defines the PROFIBUS module's characteristics. Most devices have one data area with inputs, outputs or both. Some devices have multiple data areas that are shown as additional rows.

Data Area Parameters

Area	This value is an index beginning at 1. Read-only.
Type	Specifies whether the data is input or output as well as type, digital or analog. Value can be Digital In, Analog In, Digital Out, or Analog Out.
Ref Address	Specifies the memory area that is used to map the data area. Regardless of the reference type used, input areas are considered as consumed and cannot overlap, while output areas are considered as produced and may overlap. Allowable Ranges: %AI, %AQ, %I, %Q, %G, %R, %W, %T, %M. If the number of bytes is odd, analog memories are not allowed and selections are limited to: %I, %Q, %G, %M
Length	Specifies the length of the reference. Includes the entire data area by default. If set to 0, the data area is not mapped. For discrete memories, the allowable range is [0, 8, 16, ..., X] For analog memories, the allowable range is [0, 1, 2, ..., X]
Swap Bytes	The swap bytes field is used to manipulate the byte order. Because PROFIBUS devices often do not follow the standard, the ability to change byte ordering is provided. The analog areas travel in MSB and should be swapped if LSB is required. <ul style="list-style-type: none"> ■ If Type is Digital and the module has an odd number of bytes, Swap Bytes is set to False (no swapping) and read-only. ■ If Type is Digital and the module has an even number of bytes, default is set to False. Setting Swap Bytes to True causes the LSB and MSB to be swapped before the data is mapped into PLC memory. ■ If Type is Analog, default is set to False. Setting Swap Bytes to True causes the LSB and MSB to be swapped before the data is mapped into PLC memory.

Configuring DP-V1 Settings for a Slave

Whether or not a slave device supports DP-V1 functions is indicated in the GS* file provided by the vendor of that device. For devices that do provide DP-V1 functions, support is disabled by default.

To enable DP-V1:

- 1. In the project Navigator, right click the slave and select Properties.

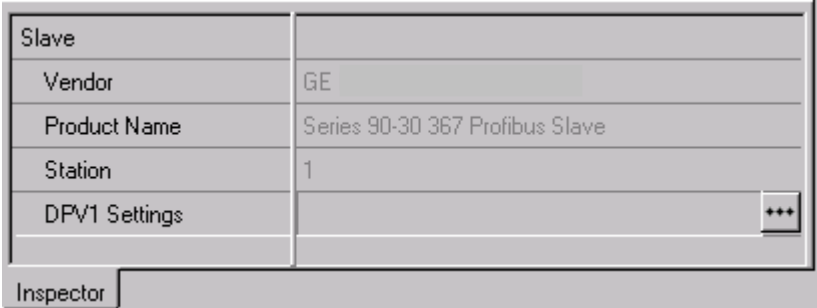

- 2. In the Properties window, click the button in the DPV1 Settings field. The PROFIBUS DPV1 Setup dialog box appears.

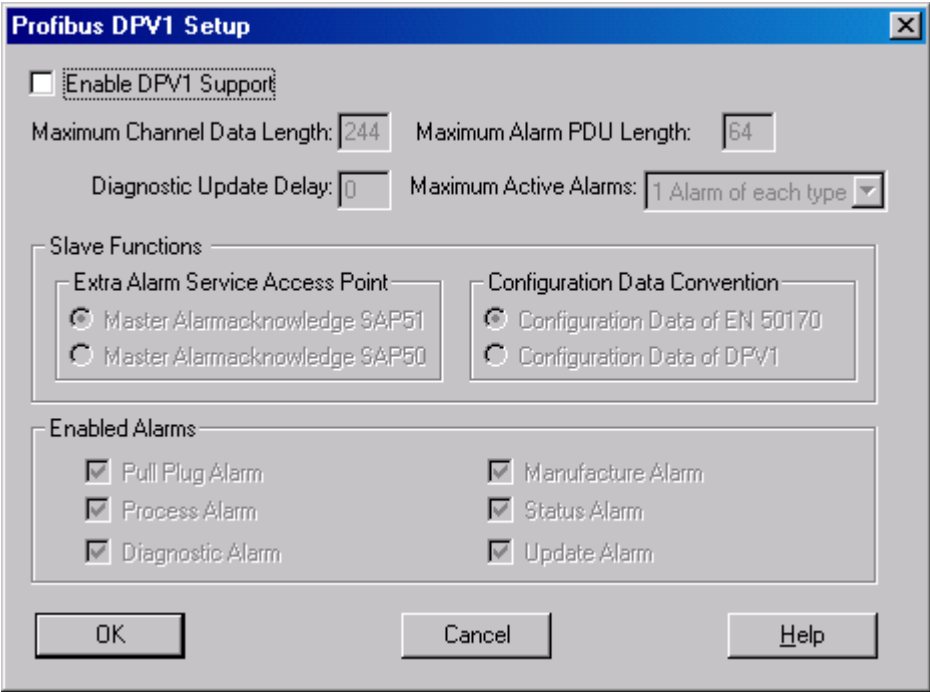

PROFIBUS DPV1 Setup Parameters

The default values in this dialog box are populated by the GS? file associated with the device.

Enable DPV1 Support	<p>Check this box to enable DPV1 settings for the selected PROFIBUS device. The device's GS? file determines which settings are editable and which are read-only.</p> <p>Clear this check box to disable DPV1 settings. The values of all parameters are retained until the DPV1 settings are enabled again for the selected device.</p>
Maximum Channel Data Length	<p>The maximum length in bytes of the DPV1 telegrams. The slave adapts its buffer size for the respective data count.</p> <p>Valid range: 4 through n bytes, where n is the value specified in the GS? file.</p>
Maximum Alarm PDU Length	<p>The maximum length in bytes of the DPV1-Alarm telegrams.</p> <p>Valid range: 4 through n, where n is calculated by the following formulas</p> $m = \text{Max_Diag_Data_Len} - 6$ $n = \text{Max}(\text{Min}(m, 64), 4)$ <p>Max_Diag_Data_Len is a value specified in the GS? file. If m is greater than 64, n is set to 64. If m is less than 4, then n is set to 4. Otherwise, n is set to m.</p> <p>If n is set to 4, the only valid Maximum Alarm PDU Length is 4.</p> <p>Default: The value n calculated by the above formulas.</p>
Diagnostic Update Delay	<p>The maximum number of extra diagnosis cycles that the master waits to obtain from a slave the release for a DATA_EXCHANGE. If the Diagnostic Update Delay is set to 0, the master waits for one diagnosis cycle before reporting an error. If the Diagnostic Update Delay is set to 15, the master waits for 16 diagnosis cycles before reporting an error. The master waits for one diagnosis cycle more than the value of the Diagnostic Update Delay.</p> <p>Some newer slave devices require more time for the consistency testing for the processing of the SET_PRM parameterizing telegrams. Therefore a simple diagnosis cycle may be insufficient until the participant can inform the Master of the release for the DATA_EXCHANGE.</p> <p>Valid range: 0 through 15.</p>
Maximum Active Alarms	<p>The maximum number of possible active alarms.</p> <p>Choices:</p> <ul style="list-style-type: none"> 1 alarm of each type 2, 4, 8, 12, 16, 24 or 32 alarms in total

Slave Functions

Extra Alarm Service Access Point	<p>The service access point (SAP) through which the master quits alarms.</p> <p>Choices:</p> <ul style="list-style-type: none"> Master Alarmacknowledge SAP51: Master quits alarms via SAP51. Master Alarmacknowledge SAP50: Master quits alarms via SAP50.
Configuration Data Convention	<p>The DPV1 data types.</p> <p>Choices:</p> <ul style="list-style-type: none"> Configuration Data of EN 50170 Configuration Data of DPV1

Enabled Alarms

Pull Plug Alarm	Editable or read-only, depending on the GS? file. When this box is checked, a slot signals the withdrawal of a module or the insertion of a module.
Process Alarm	Editable or read-only, depending on the GS? file. When this check box is checked, a process alarm signals the occurrence of an event in the connected process. For example, the event may be "upper limit value exceeded."
Diagnostic Alarm	Editable or read-only, depending on the GS? file. When this check box is checked, a diagnostic alarm signals an event within a slot. For example, events may be over temperature or short circuit.
Manufacture Alarm	Editable or read-only, depending on the GS? file. When this box is checked, manufacturer-specific alarms are enabled.
Status Alarm	Editable or read-only, depending on the GS? file. When this check box is checked, a status alarm signals a change in the state (such as run, stop, or ready) of a module.
Update Alarm	Editable or read-only, depending on the GS? file. When this check box is checked, an update alarm signals the change of a parameter in a slot, for example, by a local operation or remote access.



These configuration procedures are intended for users with at least a basic knowledge of the Machine Edition Logic Developer software and the RX3i. For information on using the software, please see the software's built-in help system.

Software configuration of the PROFIBUS slave consists of the following steps:

- Adding the PROFIBUS slave module to the configuration.
- Configuring the PROFIBUS slave parameters

Adding a PROFIBUS Slave Module to the Hardware Configuration

Add the IC695PBS301 module to the PLC rack configuration.

1. In the  Project tab of the Navigator,  expand the  Hardware Configuration folder.
2. In the Hardware Configuration folder, expand the main rack, right click the slot where the module will reside and select Add Module. The Module Catalog dialog box appears.
3. Select the IC695PBS301 PROFIBUS Slave and click the OK button. The module is added to the configuration in the Navigator window, and the module's Parameter Editor window appears in the InfoViewer window space.

Configuring PROFIBUS Slave Parameters

The PROFIBUS Slave module has three tabs that contain configurable parameters: Settings, Input Data Area and Output Data Area.

Note: The IC695PBS301 autodetects the data transmission rate.

Settings Tab

Station	The Slave module's station number that is used on the PROFIBUS network. Can be in the range from 1 to 125. Each module on a network should be given a unique station number. Default is 1. Note that the Master is commonly assigned to Station 0 (zero).
Status Address	The starting reference address used for the status data. This is a consumed range and must not overlap. Valid memory areas: %AI, %I, %Q, %G, %AQ, %R, %W, %T, or %M. Default memory area: %AI memory. The Status word provides information about the PROFIBUS slave module to the controller application. For more information, see "Get Slave Status - Reply Data Format" in chapter 6.
Length	Always two words. (A value of 2 for register memories and 32 for discrete memories.)
DP-V1 Status	The starting reference address of a 32-bit (2-word) range used at the beginning of a scan to monitor the DP-V1 master messages. (For details, see "DP-V1Status" in chapter 6. Valid memory areas: %AI, %AQ, %G, %I, %Q, %R, %W, %T, %M. Default: %AI. Valid range: For a discrete memory area: 1 through n-31, where n is the memory area's configured limit on the CPU's Memory tab. For a non-discrete memory area: 1 through n-1, where n is the memory area's configured limit on the CPU's Memory tab.
Length	Always two words. (A value of 2 for register memories and 32 for discrete memories.)
Inputs Default	Determines what values are used for the data received by the module from the master (inputs to the Slave module/outputs from the master) if communication with the master is lost. Choices are: Hold Last State (default) – Until communication resumes and new values are received each input will have the value that it had when communication was lost. Force Off – Until communication resumes and new values are received, each input will have a value of 0.

DP-V1 Class 1 Buffer Length	<p>The length of the data buffer in the PROFIBUS chip for Class 1 DP-V1 messages. This includes the length of the header buffer, which is set to 4 bytes.</p> <p>Note: This value impacts the available data width for the cyclic I/O data.</p> <p>Valid range: 0 through 244 bytes.</p> <p>PROFIBUS memory allocations for cyclic I/O data, the DP-V1 Class 1 Buffer Length, and the DP-V1 Class 2 Buffer Length conform to the following formulas:</p> <p style="padding-left: 20px;">Cyclic I/O data only: $3 (I_r + Q_r)$ must be less than or equal to 1192.</p> <p style="padding-left: 20px;">Cyclic I/O data and Class 1 buffer: $3 (I_r + Q_r) + B1r$ must be less than or equal to 1192.</p> <p style="padding-left: 20px;">Cyclic I/O data and Class 2 buffer: $3 (I_r + Q_r) + B2r$ must be less than or equal to 1160.</p> <p style="padding-left: 20px;">Cyclic I/O data and Class 1 and Class 2 buffers: $3 (I_r + Q_r) + B1r + B2r$ must be less than or equal to 1152.</p> <p>The above formulas use the following acronyms:</p> <p style="padding-left: 20px;">B1r: $(4 + \text{DP-V1 Class 1 Buffer Length})$, rounded up to a multiple of 8</p> <p style="padding-left: 20px;">B2r: $(4 + \text{DP-V1 Class 2 Buffer Length})$, rounded up to a multiple of 8</p> <p style="padding-left: 20px;">I_r: length of input data, rounded up to multiple of 8</p> <p style="padding-left: 20px;">Q_r: length of output data, rounded up to multiple of 8</p> <p>Note: The 4 additional bytes in B1r and B2r indicate SPC3 internal administration data.</p>
DP-V1 Class 2 Buffer Length	<p>The length of the data buffer in the PROFIBUS chip for Class 2 DP-V1 messages. This includes the length of the header buffer, which is set to 4 bytes.</p> <p>Note: This value impacts the available data width for the cyclic I/O data.</p> <p>Valid range: 0 through 244 bytes.</p> <p>PROFIBUS memory allocations for cyclic I/O data, the DP-V1 Class 1 Buffer Length, and the DP-V1 Class 2 Buffer Length conform to the formulas given under the DP-V1 Class 1 Buffer Length parameter.</p>
I/O Scan Set	<p>The scan set (as defined in the CPU's Scan Sets tab) to be assigned to this module.</p> <p>Valid range: 1 through 32.</p> <p>Default: 1</p>

Input Data Area Tab

The input data area describes data received over the network by the Slave module from the network Master. These inputs are mapped, using the Input Data Area tab, into specific memory locations in the PLC where the Slave module resides.

Area	A read-only identifier for the row. Valid range: 1 to 32.
Type	Data type of area being defined. Valid types are Digital In, Analog In, and Empty. The default value is Empty.
Size	Describes the size of the data area on the network. Set to 0 and read-only if Type is set to Empty. Valid ranges: If Type is set to Analog In (Word): 1, 2, 3, 4, 8, 12, 16, 20, 32, 64 If Type is set to Digital In (Byte): 1, 2, 3, 4, 8, 12, 16, 20, 32, 64
Note:	The total number of input bytes for all entries cannot exceed 244. A value of 0 sets Type to Empty.
Units	This read-only field gives the units for the Type specified. Valid ranges: If Type is set to Empty or Digital In: Byte If Type is set to Analog In: Word
Ref Address	Location in PLC memory where the received data is mapped. This field is read-only if Size is set to 0. This is a consumed range and must be a non-overlapping range in %AI, %I, %Q, %G, %AQ, %R, %T, %M or %W. If Type is set to Digital In and the number of bytes (Size) is odd, an address in discrete memory must be used: %I, %Q, %G, %M, or %T. Default: For Digital In, next available address in %I For Analog In, next available address in %AI
Length	The number of %G, %I, %M, %Q, or %T bits, or the number of %AI, %AQ, %R, or %W 16-bit registers (words) used for the input area, starting at the Ref Address location.

Output Data Area Tab

The output data area describes data sent over the network by the Slave module to the network Master. These outputs are mapped, using the Output Data Area tab, from specific memory locations in the PLC where the Slave module resides.

Area	Read-only identifier for the row. Valid range: 1-32.
Type	Data type of area being defined. Valid types are Digital Out, Analog Out, and Empty. The default value is Empty.
Size	Describes the size of the data area on the network. Set to 0 and read-only if Type is set to Empty. Valid ranges: If Type is set to Digital Out (Byte): 1, 2, 3, 4, 8, 12, 16, 20, 32, 64 If Type is set to Analog Out (Word): 1, 2, 3, 4, 8, 12, 16, 20, 32, 64
Note:	The total number of output bytes for all entries cannot exceed 244. A value of 0 sets Type to Empty.
Units	This read-only field gives the units for the Type specified. If Type is set to Empty or Digital Out: Byte If Type is set to Analog Out: Word
Ref Address	Location in PLC memory where the data to be sent is mapped. This field is read-only if Size is set to 0. This is a produced range and can be any range in %AI, %I, %Q, %G, %AQ, %R, %W, %T, or %M. If Type is Digital Out and the number of bytes (Size) is odd, an address in discrete memory must be used: %I, %Q, %G, %M, or %T. Overlaps with another produced range are not considered fatal and can be included in a valid configuration. Default: For Digital Out, next available address in %Q For Analog Out, next available address in %AQ
Length	The number of %G, %I, %M, %Q, or %T bits, or the number of %AI, %AQ, %R, or %W 16-bit registers (words) used for the output area, starting at the Ref Address location.

Chapter 5

PROFIBUS Master Status and Diagnostics

There are four methods for obtaining status and diagnostic data for the PROFIBUS Master module:

- Observing and interpreting the LED indicators on the PROFIBUS Master module, page 5-2
- Using the Status Arrays, page 5-3
- Monitoring the PLC Fault Table, page 5-4
- Using Communications Request (COMMREQ) ladder logic instructions to instruct the PROFIBUS Master to gather diagnostic or status data and report it to the host controller CPU, page 5-5
- Obtaining device information such as firmware and hardware versions, page 5-24

PROFIBUS Master Module LEDs

LED	Color	State	Frequency	Meaning
PROFIBUS OK	Green	Static On	NA	Module has power and backplane reset is complete.
	Off	NA	NA	Module does not have power or backplane reset is not complete.
NETWORK	Yellow	Static On	n/a	Module is holding the PROFIBUS token and is able to transmit PROFIBUS telegrams.
		Flashing Non-cyclic	Between 0.5 Hz and 100 Hz	Module is sharing the PROFIBUS token with other master on the network.
		Off	NA	Module is not configured or has not received the token permission from the network.
	Red	Static On	NA	Module has found a communication problem with at least one network slave, usually connection timeout.
MOD STATUS	Green	Flashing Cyclic	5 Hz	No error in configuration found; module is ready for communication; it tries to open a connection to a slave, but is not connected yet.
		Flashing Non-cyclic	3 times fast at 5 Hz, 8 times between 0.5 Hz and 1 Hz	Power Up: Configuration missing. For details on hardware configuration, refer to Chapter 3. Runtime: Firmware has found a critical problem, such as a watchdog timeout.
		Static On	NA	Module has established at least one connection to another device on the network.
	Yellow	Flashing Cyclic	1 Hz	Module is in boot-loader mode and is waiting for firmware download.
		Flashing Cyclic	5Hz	Firmware download is in progress.
		Flashing Non-cyclic	3 times fast at 5 Hz, 8 times between 0.5 Hz and 1 Hz	Hardware or non-recoverable runtime error detected, module may need to be replaced.
	Off	NA	NA	No power.

Status Arrays

The starting addresses of these arrays are set in the hardware configuration. For details, see “Configuring the PROFIBUS Master Module” in chapter 3.

Slave Status Bit Array

The Slave Status bit array contains a bit for each slave. If communication with a slave has no errors, the bit corresponding to the slave (determined by its network address) is set. If the communication has errors or is not occurring for any reason, the bit is cleared. The Master also maintains its own status in the bit corresponding to its network address.

Slave Diagnostics ID Array

If diagnostics are pending, the first word of this two-word array contains the station address of the first slave that has diagnostics. The diagnostics can be read using the Get Device Diagnostics COMMREQ (command 4), described on page 5-13. This clears the word and the master then places the next pending diagnostic address into the Slave Diagnostics word. If this word is zero there are no pending diagnostics.

The second word of this array is reserved and set to 0.

DPV1 Alarm Status Array

The 32-bit DPV1 Alarm Status array is used at the beginning of a scan to receive the station address of a slave that has sent a DPV1 Alarm message. If another slave has sent a DPV1 alarm message, it is ignored until the first one has been serviced, and will then appear in a subsequent scan. For details on the status format, refer to “DPV1 Alarm Acknowledge COMMREQ” on page 5-22.

Slave Configured Bits

This 128-bit array indicates which slaves on the PROFIBUS network are configured. Each slave has a corresponding bit in this array. A slave's configuration status address equals Start Address + Station Address of the slave. For example, if the configuration status bits are mapped to %I00001, the status for the slave at Station Address 5 would be found at %I00001 + 5=%I00006.

Slave Diagnostic Bits

This 128-bit array indicates which slaves on the PROFIBUS network have diagnostic data available.

The diagnostics can be read using the Get Device Diagnostics COMMREQ (command 4), described on page 5-13.

Each slave has a corresponding bit in this array. A slave's diagnostic status address equals Start Address + Station Address of the slave. For example, if the configuration status bits are mapped to %I00001, the status for the slave at Station Address 5 would be found at %I00001 + 5=%I00006.

Communication Requests

The Communication Request function (COMMREQ) allows the program to communicate with a GE Intelligent Platforms module, such as a PROFIBUS Master.

Note: For details on the operation of the COMMREQ function block, refer to Appendix A.

The figure below illustrates the flow of information between the host controller CPU and the PROFIBUS master.

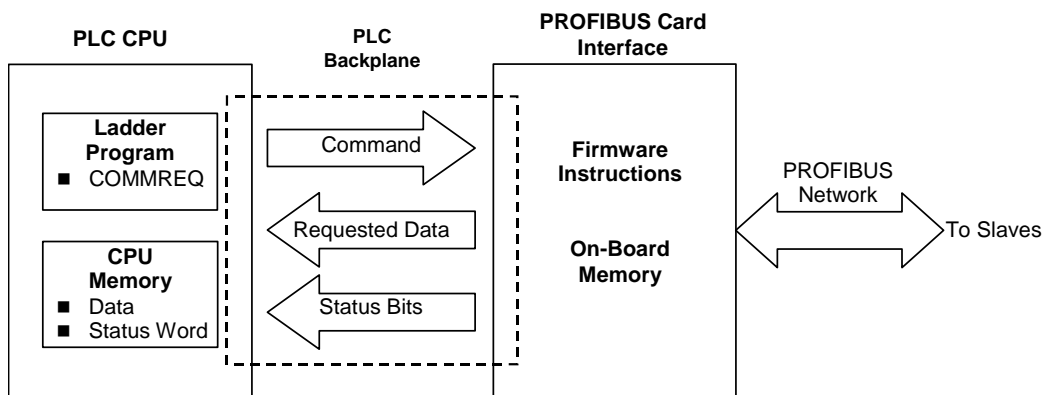

Communications Request Operation for PROFIBUS Master

The PROFIBUS Master module supports the following COMMREQ commands and responses.

Command Code	Name	Description	Page No.
1	Get Device Status	Retrieves detailed status information for the specified node.	5-6
2	Get Master Status	Retrieves detailed status information for the Master.	5-8
4	Get Device Diagnostics	Retrieves diagnostics for a specified Slave.	5-13
5	Read Module Header	Retrieves module header information.	5-14
6	Clear Counters	Clears the counters in the Module Header	5-16
7	DPV1 Read Request	Performs a DPV1 read request from a slave device.	5-17
8	DPV1 Write Request	Performs a DPV1 write request to a slave device.	5-19
9	DPV1 Alarm Acknowledge	Acknowledges a DPV1 alarm request.	5-22

The following table lists the memory types that can be used for the Status Block and Reply Data areas.

COMMREQ Status Word Memory Type Codes

Memory Type	Memory Type	Decimal code
%I	Discrete input table (Byte mode)	16
%Q	Discrete output table (Byte mode)	18
%W	Word memory	196
%R	Register memory	8
%AI	Analog input table	10
%AQ	Analog output table	12
%T	Discrete temporary memory (Byte)	20
%M	Discrete internal memory (Byte)	22

Get Device Status (1)

The Get Device Status Command retrieves detailed status information for the specified device.

Note: This request retrieves diagnostics directly from the slave device using a PROFIBUS network request. If network scan time is critical, PROFIBUS network impact should be considered when using this COMMREQ command.

Get Device Status Command Block

Word Offset	Value Dec (Hex)	Definition
Word 1	5 (0005)	Length of command Data Block in words.
Word 2	0 (0000)	Always 0 (no-wait mode request).
Word 3	See page 5-5.	Memory type of COMMREQ status word. (Words 3 and 4 specify the starting address where the status word will be written.)
Word 4	0-based offset	COMMREQ status word address minus 1. Example: If Words 3 and 4 contain values of 8 and 9 respectively, the status word will be written to %R10.
Word 5	0 (0000)	Reserved
Word 6	0 (0000)	Reserved
Word 7	1 (0001)	Command code for the COMMREQ to be executed. Get Device Status = 1.
Word 8	See page 5-5.	Memory type for the reply data. (Words 8—9 specify the starting address where the response will be written.)
Word 9	0-based offset	Starting address to which the response will be written. The value entered is the 0-based offset from the beginning of PLC memory for the memory type specified in Word 8. This offset will be in bits, bytes, or words depending on the memory type specified. Valid ranges of values depend on the PLC's memory ranges. Example: If Words 8 and 9 contain values of 8 and 250 respectively, the response will be written to %R251.
Word 10	Words: 9 (0009) Bytes: 18 (0012)	Maximum size of response area in words. Must be 9 if word memory type is used; 18 if discrete memory type is used.
Word 11	0—125 (0—007D)	The address of the device the COMMREQ is to retrieve device status from. If the address of the master or a slave that is not on the bus is entered, a COMMREQ Status Word response of 4 will be returned.

Get Device Status Reply Data Format
– Response written to location specified by Words 8 & 9

Word	Name	Description
1	Command Code	Echo of Command Code that this data block is replying to (0x0001).
2	Device Status 1	Code indicating the status of the slave device. See tables below.
3	Device Status 2	Code indicating the status of the slave device. See tables below.
4	Device Status 3	Code indicating the status of the slave device. See tables below.
5	Master Address	The address of the master connected to this slave. If the slave is not parameterized this value will be 255 (0x00FF).
6	Ident Number	The Ident Number of the slave.
7 ...9	Reserved for future use.	Word 10 of the Get Device Status command block should specify a minimum of 9 words (18 bytes) to accommodate possible future use of this space.

Device Status 1 – Word 2

Bit	Name	Description
0	Sta._Non_Exist	No response from slave device. The station is non-existent.
1	Sta._Not_Ready	Slave not ready.
2	Cfg_Fault	Slave has incorrect parameterization.
3	Ext_Diag	The extended diagnostics area is used.
4	Not_Supp	Unknown command is detected by the slave.
5	Inv._Slv_Res	Invalid slave response.
6	Prm_Fault	Last parameterization telegram was faulty.
7	Master_Lock	Slave is controlled by another master.
8 ... 15	RFU	Reserved for further use

If this status word is zero, the slave device has no errors. The non-zero values, which are errors, are defined in the following table.

Device Status 2 – Word 3

Bit	Name	Description
0	Prm_Req	Slave must be parameterized.
1	Stat_Diag	This bit remains active until all diagnostic data has been retrieved from the slave.
2	1	Always a value of one.
3	WD_On	Slave watchdog is activated.
4	Freeze_Mode	Freeze command active.
5	Sync_Mode	Sync command active
6	Reserved	Reserved.
7	Deactivated	Slave not active.
8 ... 15	RFU	Reserved for further use

Device Status 3 – Word 4

The Device Status 3 word has only one active meaning. If this word is set to 0x0080 then the slave has an Extended Diagnostic data overflow. This means that the slave has a large amount of diagnostic data and cannot send it all.

Get Master Status (2)

The Get Master Status Command provides detailed status information about the Master module.

Warning

When a Get Master Status COMMREQ is called on the first scan of the PLC, the COMMREQ may return a false positive, indicating that the PROFIBUS network has “1 or more slaves not in IO exchange mode.” The Get Master Status COMMREQ should not be called or relied upon for any data during the first scan of the PLC.

Get Master Status Command Block

Word Offset	Value Dec (Hex)	Definition
Word 1	4 (0004)	Length of command Data Block in words
Word 2	0 (0000)	Always 0 (no-wait mode request)
Word 3	See page 5-5.	Memory type of COMMREQ status word. (Words 3 and 4 specify the starting address where the status word will be written.)
Word 4	0-based offset	COMMREQ status word address minus 1. Example: if Words 3 and 4 contain values of 8 and 9 respectively, the status word will be written to %R10.
Word 5	0 (0000)	Reserved
Word 6	0 (0000)	Reserved
Word 7	2 (0002)	Command code for the COMMREQ to be executed. Get Master Status = 2.
Word 8	See page 5-5.	Memory type for the reply data. (Words 8—9 specify the starting address where the response will be written.)
Word 9	0-based offset	Starting address to which the response will be written. The value entered is the 0-based offset from the beginning of PLC memory for the memory type specified in Word 8. This offset will be in bits, bytes, or words depending on the memory type specified. Valid ranges of values depend on the PLC's memory ranges. Example: If Words 8 and 9 contain values of 8 and 250 respectively, the response will be written to %R251.
Word 10	Words: 9 (0009) Bytes: 18 (0012)	Maximum size of response area. Must be 9 if word memory type is used; 18 if discrete memory type is used.

**Get Master Status Reply Data Format –
Response written to location specified by Words 8 & 9**

Word	Name	Description
1	Command Code	Echo of Command code that this data block is replying to. (0x0002)
2	Global State Bits	Bits indicating the global state of the master. See “Global State Bits.”
3	DPM State	Control state of the Dual Port Memory in the master. See “DPM State” on page 5-10.
4L	Error Remote Address	Remote address of device with error. See “Error Remote Address” on page 5-10.
4H	Error Event	Error code response to the Error Remote address. See “Error Event” on page 5-10.
5 ... 9	Reserved for future use	Word 10 of the Get Master Status command block should specify a minimum of 9 words to accommodate possible future use of this space.

Global State Bits

The master’s global state is reported in Word 2 of the Get Master Status reply data and the low byte of Word 4 in the Read Module Header reply data (described on page 5-15).

If there are no errors reported by the master, all bits in this word have a value of zero. The following table provides definitions for bits with a value of 1.

Bit	Name	Description
0	CTRL	CONTROL-ERROR: Parameterization error.
1	ACLR	AUTO-CLEAR-ERROR: Master has stopped communications to all slaves and reached the auto-clear end state.
2	NEXC	NON-EXCHANGE-ERROR: At least one slave has not reached the data exchange state and no process data is being exchanged with it.
3	FAT	FATAL-ERROR: Because of major network fault, no further bus communication is possible.
4	EVE	EVENT-ERROR: The master has detected bus short circuits. The number of detected events is reported in Word 6, BusErrorCnt, of the Read Module Header reply. The bit is set only when the first event is detected.
5	NRDY	HOST-NOT-READY-NOTIFICATION: If this bit is set, the HOST program is not ready to communicate.
6	TOUT	TIMEOUT-ERROR: The timeout supervision time has been exceeded because of rejected PROFIBUS telegrams. This error indicates bus short circuits that cause the master to interrupt communications. The number of detected timeouts is reported in Word 7, TimeOutCnt, of the Read Module Header reply. The bit is set only when the first timeout is detected.
7	NA	Reserved.

DPM State

This byte indicates the current control state of the Dual Port Memory in the master. DPM State is reported in Word 3 of the Get Master Status reply data and the high byte of Word 4 of the Read Module Header reply data (described on page 5-15).

The following table provides definitions of the possible values.

Value	DPM Master State	Description
0x00	OFFLINE	The master system has been switched on, but there is no data transfer on the bus.
0x40	STOP	The master loads bus parameters and initializes the diagnostic buffer. No data transfer takes place.
0x80	CLEAR	The master parameterizes and configures the slaves through the bus. It reads the input data, but retains the output data.
0xC0	OPERATE	User data transfer is active. New output data is transmitted cyclically and the latest input data is read.

Error Remote Address (Low Byte Word 4)

The Error Remote Address field contains the physical address of a device that has caused an error. If the master is the source of the error, this byte contains the value 255. If the error was detected at or reported by a network device, the byte contains the source station address and has a range from 0 to 125. If this field contains an address, the Error Event byte will contain a code that identifies the error.

Error Event (High Byte Word 4)

The Error Event byte contains the error code of the device identified in the Error Remote Address field. This error code is also reported in the high byte of Word 5 of the Read Module Header reply data (described on page 5-15).

For descriptions of master errors, see the table on page 5-11. For slave device errors, see page 5-12.

Error Event Codes for PROFIBUS Master (Error Remote Address of 255)

Code	Indication	Source	Corrective Action
0	No errors are present.	None	None.
50	USR_INTF-Task not found.	Master	Firmware is invalid. Module must be updated.
51	No global data-field.	Master	Firmware is invalid. Module must be updated.
52	FDL-Task not found.	Master	Firmware is invalid. Module must be updated.
53	PLC-Task not found.	Master	Firmware is invalid. Module must be updated.
54	Non-existing master parameters.	Master	Download hardware configuration.
55	Faulty parameter value in the master parameters	Configuration	Firmware is invalid. Module must be updated.
56	Non-existing slave parameters.	Configuration	Download hardware configuration.
57	Faulty parameter value in a slave parameters data file.	Configuration	Check GSD file for possible incorrect slave parameterization values.
58	Duplicate slave address.	Configuration	Check configured slave addresses in project.
59	Configured send process data offset address of a slave is outside the allowable range of 0—255.	Configuration	Check slave configuration in project.
60	Configured receive process data offset address of a slave is outside the allowable range of 0—255.	Configuration	Check slave configuration in project.
61	Data areas of slaves overlapping in the send process data.	Configuration	Check slave configuration in project.
62	Data areas of slaves are overlapping in the receive process data.	Configuration	Check slave configuration in project.
63	Unknown process data handshake.	Master	Problem with master's startup parameters.
64	Free RAM exceeded.	Master	Master has a hardware issue.
65	Faulty slave parameter dataset.	Configuration	Check GSD file for possible incorrect slave parameterization datasets.
202	No memory segment free.	Master	Master has a hardware issue.
212	Faulty reading of a database.	Configuration	Execute download of configuration database again.
213	Structure used by the operating system is faulty.	Master	Master has a hardware issue.
220	Software Watchdog error.	Host	Firmware watchdog has an error.
221	No Data Acknowledge in process data handshake.	Host	Firmware is having trouble with Host acknowledgement.
222	Master in Auto Clear mode	Slave Device	The auto clear mode was activated, because one slave is missing during runtime.
225	No further segments.	Master	Master has a hardware issue.

Error Event Codes for Slave Devices (Error Remote Address Not Equal to 255)

Code	Indication	Source	Corrective Action
0	No errors	NA	NA
2	Slave station reports data overflow.	Master Telegram	Check length of configured slave parameter or configuration data.
3	Master is requesting a function that is not supported in the slave.	Master Telegram	Check if slave is PROFIBUS-DP norm compatible.
9	No answering data, although the slave must respond with data.	Slave	Check configuration data of the slave and compare it with the physical I/O data length.
17	No response from the slave.	Slave	Check bus cable and bus address of slave.
18	Master not in the logical token ring.	Master	Check FDL-Address of master or highest station address of other master systems. Examine bus cabling for bus short circuits.
21	Faulty parameter in request.	Master Telegram	Master has a firmware issue.

Get Device Diagnostics (4)

The Get Device Diagnostics command retrieves detailed status information for the specified device.

Get Device Diagnostics Command Block

Word Offset	Value Dec (Hex)	Definition
Word 1	5 (0005)	Length of command Data Block in words
Word 2	0 (0000)	Always 0 (no-wait mode request)
Word 3	See page 5-5.	Memory type of COMMREQ status word. (Words 3 and 4 specify the starting address where the status word will be written.)
Word 4	0-based offset	COMMREQ status word address minus 1. Example: if Words 3 and 4 contain values of 8 and 9 respectively, the status word will be written to %R10.
Word 5	0 (0000)	Reserved
Word 6	0 (0000)	Reserved
Word 7	4 (0004)	Command code for the COMMREQ to be executed. Get Device Diagnostics = 4.
Word 8	See page 5-5.	Memory type for the reply data. (Words 8—9 specify the starting address where the response will be written.)
Word 9	0-based offset	Starting address to which the response will be written. The value entered is the 0-based offset from the beginning of PLC memory for the memory type specified in Word 8. This offset will be in bits, bytes, or words depending on the memory type specified. Valid ranges of values depend on the PLC's memory ranges. Example: If Words 8 and 9 contain values of 8 and 250 respectively, Starting Address to write response (the response will be written to %R251.
Word 10	Words: 9 (0009) Bytes: 18 (0012)	Maximum size of response area. Must be 9 if word memory type is used; 18 if discrete memory type is used. If the Diagnostic data does not fit in this memory block, a value of 7 is returned in the COMMREQ Status Word. You are responsible for assuring that this area is large enough to contain the requested data without overwriting other application data.
Word 11	0—125 (0—007D)	Specifies the address of the device the COMMREQ is retrieving device status from. If the address of the master or a slave that is not on the bus is entered, a COMMREQ Status Word response of 4 will be returned.

Get Device Diagnostics Reply Data Format – Response written to location specified by Words 8 & 9

Word	Name	Description
1	Command Code	Echo of the Command Code = 4.
2	Size x of Diagnostics Received	Size in bytes of the Extended Diagnostics received.
3	Diag 0 (Low Byte) Diag 1 (High Byte)	Extended diagnostic data bytes.
4	Diag 2 (Low Byte) Diag 3 (High Byte)	Extended diagnostic data bytes.
...
2 + (x/2)	Diag ...x (Low Byte) Diag ...x+1 (High Byte)	Extended diagnostic data bytes.

Read Module Header (5)

The Read Module Header command retrieves Network Diagnostic Information and statistics from the device

Read Module Header Command Block

Word Offset	Value Dec (Hex)	Definition
Word 1	4 (0004)	Length of command Data Block in words
Word 2	0 (0000)	Always 0 (no-wait mode request)
Word 3	See page 5-5.	Memory type of COMMREQ status word. (Words 3 and 4 specify the starting address where the status word will be written.)
Word 4	0-based offset	COMMREQ status word address minus 1. Example: if Words 3 and 4 contain values of 8 and 9 respectively, the status word will be written to %R10.
Word 5	0 (0000)	Reserved
Word 6	0 (0000)	Reserved
Word 7	5 (0005)	Command code for the COMMREQ to be executed. Read Module Header = 5.
Word 8	See page 5-5.	Memory type for the reply data. (Words 8—9 specify the starting address where the response will be written.)
Word 9	0-based offset	Starting address to which the response will be written. The value entered is the 0-based offset from the beginning of PLC memory for the memory type specified in Word 8. This offset will be in bits, bytes, or words depending on the memory type specified. Valid ranges of values depend on the PLC's memory ranges. Example: If Words 8 and 9 contain values of 8 and 250 respectively, (the response will be written to %R251.
Word 10	Words: 20 (0014) Bytes: 40 (0028)	Size in words of response area, 20 if word memory type is used, 40 if discrete memory is used. You are responsible for assuring that this area is large enough to contain the requested data without overwriting other application data

Read Module Header Reply Data Format

Word	Name	Description
1	Command Code	Echo of the Command Code = 5.
2	Interface Type	2 if the interface is a master. 1 if the interface is a slave.
3	Firmware Revision	Indicates the current firmware revision: high byte is major version number; low byte is minor version number.
4L	Global State Bits (Low Byte)	Indicates the global state of the master. See "Global State Bits" on page 5-9.
4H	DPM State (High Byte)	Dual Port Memory control state of the master. See "DPM State" on page 5-10.
5L	Error Remote Address	The physical address of a device that has caused an error. <ul style="list-style-type: none"> ■ If the master is the source of the error, this byte contains the value 255. ■ If the error was detected at or reported by a network device, the byte contains the source station address and has a range from 0 to 125. If this field is non-zero, the Error Event byte will contain a code that identifies the error.
5H	Error Event	Error code response to the Error Remote address. See "Error Event" on page 5-10.
6	BusErrorCnt	Number of major bus error, for example bus short circuits.
7	TimeOutCnt	Number of rejected PROFIBUS telegrams.
8	SlaveDiagReq	Number of slave diagnostics requests.
9	GlobalConReq	Number of global control requests.
10	DataExReq	Number of data exchange cycles.
11	DataExReqPos	Number of positive data exchange cycles.
12	DataExReqNeg	Number of negative data exchange cycles.
13	DataExAllReq	Number of all active data exchange cycles.
14	DataExAllReqPos	Number of data exchange cycles (all positive requests).
15	DataExAllReqNeg	Number of data exchange cycles (all negative requests.).
16	SlavesFound	Number of slaves found on bus. Note: Only the slaves on the network that do not belong to another master are counted as SlavesFound.
17	SlavesConfigured	Number of configured slaves on the bus.
18	SlavesActive	Number of slaves active in data exchange mode.
19	DataControlTime	Time (in ms) of the data exchange.
20	Reserved	Reserved for future use

Clear Counters (6)

This command sets the counters in the PROFIBUS Master module to zero. For a list of counters, see words 6 through 18 of the “Read Module Header Reply Data Format” on page 5-15.

Clear Counters Command Block

Word Offset	Value Dec (Hex)	Definition
Word 1	4 (0004)	Length of command Data Block in words
Word 2	0 (0000)	Always 0 (no-wait mode request)
Word 3	See page 5-5.	Memory type of COMMREQ status word. (Words 3 and 4 specify the starting address where the status word will be written.)
Word 4	0-based offset.	COMMREQ status word address minus 1. Example: if Words 3 and 4 contain values of 8 and 9 respectively, the status word will be written to %R10.
Word 5	0 (0000)	Reserved
Word 6	0 (0000)	Reserved
Word 7	6 (0006)	Command code for the COMMREQ to be executed. Clear Counters = 6.
Word 8	See page 5-5.	Memory type for the response. (Words 8—9 specify the starting address where the response will be written.)
Word 9	0-based offset.	Starting address to which the response will be written. The value entered is the 0-based offset from the beginning of PLC memory for the memory type specified in Word 8. This offset will be in bits, bytes, or words depending on the memory type specified. Valid ranges of values depend on the PLC’s memory ranges. Example: If Words 8 and 9 contain values of 8 and 250 respectively, the response will be written to %R251.
Word 10	Word 2 (0002) Byte: 4 (0004)	Maximum size of response area: Must be 2 if word memory type is used, 4 if discrete memory is used. If Response Memory Size is set greater than 2 words (4 bytes), the COMMREQ will fail.

Clear Counters Reply Data Format

Word	Name	Description
Word 1	CommandCode	Echo of Command code that this data block is replying to. (0x0006)
Word 2	StatusCode	Reports 1 for success and 0 for failure.

DP-V1 Read Request (7)

The DPV1 Read Request Block is used by the master to perform a DP-V1 Read Request to a slave device. The Command/Response format of this block is as follows.

DP-V1 Read Request Command Block

Word Offset	Value Dec (Hex)	Definition
1	7 (0007)	Length of command Data Block in words
2	0 (0000)	Always 0 (no-wait mode request)
3	See page 5-5.	Memory type of COMMREQ status word. (Words 3 and 4 specify the starting address where the status word will be written.)
4	0-based offset	COMMREQ status word address minus 1. Example: if Words 3 and 4 contain values of 8 and 9 respectively, the status word will be written to %R10.
5	0 (0000)	Reserved
6	0 (0000)	Reserved
7	7 (0007)	Command code for the COMMREQ to be executed. DP-V1 Read Request = 7.
8	See page 5-5.	Memory type for the reply data. (Words 8—9 specify the starting address where the response will be written.)
9	0-based offset	Starting address to which the response will be written. The value entered is the 0-based offset from the beginning of PLC memory for the memory type specified in Word 8. This offset will be in bits, bytes, or words depending on the memory type specified. Valid ranges of values depend on the PLC's memory ranges. Example: If Words 8 and 9 contain values of 8 and 250 respectively, the response will be written to %R251.
10	Words: 6+x (0006+x) Bytes: 12+x (000C + x)	Size of the response plus the size of the expected DPV1 data from the slave. For word memory types, (x ranges from 1 to 120 words. For discrete memory types, x ranges from 1 to 240 bytes. Example: If the expected length of the DP-V1 response COMMREQ is 8 words, word 10 should be 6 + 8 = 14.
11	0—125 (0—007D)	The address of the device the COMMREQ is to retrieve device status from. If the address of the master or a slave that is not on the bus is entered, a COMMREQ Status Word response of 4 will be returned.
12	0—254 (0—00FE)	Slot Number. Slot and Index depend on the specific slave device. Please refer to the user documentation for the slave for further details.
13	0—254 (0—00FE)	Index.

*DP-V1 Read Request Response Data Format –
Response written to location specified by Words 8 & 9*

Word	Name	Description
1	Command Code	Echo of the Command Code = 7.
2	Slave Address	Echo of Slave address from command.
3	Slot Number	Echo of Slot number from command.
4	Index	Echo of Index from command.
5	Length	Length of received data. In words if word Memory Type was specified in the command block. In bytes for discrete memory.
6	ReadReqStat	The DPV1 status of the read request. This status word indicates success or failure of the DPV1 request. See status table on page 5-20.
If ReadReqStat = CON_AD (54)		
7L	Data Low	Indicates Error Code 1.
7H	Data High	Indicates Error Code 2.
If ReadReqStat = 0		
7L	Data Low	First received data byte from slave.
7H	Data High	Second received data byte from slave.
...
7+(x-1)L	Data Low
7+(x-1)H	Data High	Last received data byte from slave.

DP-V1 Write Request (8)

The DP-V1 Write Request Block is used by the master to perform a DP-V1 Write Request to a slave device. The Command/Response format of this block is as follows.

DP-V1 Write Request Command Block

Word Offset	Value Dec (Hex)	Definition
1	8+x (0008+x)	Length of command Data Block in words.
2	0 (0000)	Always 0 (no-wait mode request)
3	See page 5-5.	Memory type of COMMREQ status word. (Words 3 and 4 specify the starting address where the status word will be written.)
4	0-based offset	COMMREQ status word address minus 1. Example: if Words 3 and 4 contain values of 8 and 9 respectively, the status word will be written to %R10.
5	0 (0000)	Reserved
6	0 (0000)	Reserved
7	8 (0008)	Command code for the COMMREQ to be executed. DP-V1 Write Request = 8.
8	See page 5-5.	Memory type for the reply data. (Words 8—9 specify the starting address where the response will be written.)
9	0-based offset	Starting address to which the response will be written. The value entered is the 0-based offset from the beginning of PLC memory for the memory type specified in Word 8. This offset will be in bits, bytes, or words depending on the memory type specified. Valid ranges of values depend on the PLC's memory ranges. Example: If Words 8 and 9 contain values of 8 and 250 respectively, the response will be written to %R251.
10	Words: 12 (000C) Bytes: 24 (0018)	Size of response. Always 12 if word memory type is used, 24 for discrete memory.
11	0—125 (0—007D)	Specifies the address of the device the COMMREQ is retrieving device status from. If the address of the master or a slave that is not on the bus is entered, a COMMREQ Status Word response of 4 will be returned.
12	0—254 (0—00FE)	Slot Number. Slot and Index depend on the specific slave device. Please refer to the user documentation for the slave for further details.
13	0—254 (0—00FE)	Index
14	Word: 1—120 Byte: 1—240	Length x of data to be written in words or bytes. The uppermost bit determines whether the size value is interpreted as words or bytes. For example, a value of 0x0005 indicates a data size of five words while a value of 0x8005 indicates a data size of five bytes.
15—(14+x)	... (...)	Data to be written.

*DP-V1 Write Request Response Data Format –
Response written to location specified by Words 8 & 9*

Word	Name	Description
1	Command Code	Echo of the Command Code = 8.
2	Slave Address	Echo of Slave address from command.
3	Slot Number	Echo of Slot number from command.
4	Index	Echo of Index from command.
5	Length	Actual length of received data. In words if word type memory was specified in the command block. In bytes if discrete memory was used.
6	WriteReqStat	The DPV1 status of the read request. This status word indicates success or failure of the DPV1 request. See “DPV1 Return Status and Error Codes” below.
If ReadReqStat = CON_AD (54)		
7L	Data Low	Indicates Error Code 1.
7H	Data High	Indicates Error Code 2.
8–12	Reserved	NA

DPV1 Return Status and Error Codes

The tables below shows possible return messages contained in the ReadReqStat / WriteReqStat fields of the DPV1 requests discussed above. Also included are the Error Code 1 and 2 fields.

Code	Name	Indication
0	CON_OK	Service executed without error.
2	CON_RR	Resource unavailable.
3	CON_RS	Requested function not supported by the slave.
9	CON_NR	No answer data however, slave did respond.
17	CON_NA	No response from slave.
18	CON_DS	Master not in logical bus.
25	CON_NP	Unrecognizable reply from slave.
54	CON_AD	Negative response, Access denied.
129	REJ_SE	Master is about to stop DPV1 communication or DPV1 is not in Open state.
130	REJ_ABORT	Master has stopped DPV1 communication automatically.
131	REJ_PS	A previous service is still in process.
132	REJ_LE	The length indicator oversteps maximum configured size.
133	REJ_IV	Wrong parameter in request
154	REJ_COM	Unknown command.

Error Code 1

The bits that make up the Error Code 1 byte are defined below.

D7	D6	D5	D4	D3	D2	D1	D0
Error Class				Error Code			

Error Class	Meaning	Error Code	Meaning
0 to 9	Reserved	0 to 15	Reserved
10	Application	0	Read error
		1	Write error
		2	Module failure
		3 to 7	Reserved
		8	Version conflict
		9	Feature not supported
		10 to 15	Device specific
11	Access	0	Invalid index
		1	Write length error
		2	Invalid slot
		3	Type conflict
		4	Invalid area
		5	State conflict
		6	Access denied
		7	Invalid range
		8	Invalid parameter
		9	Invalid type
		10 to 15	Device specific
12	Resource	0	Read constrain conflict
		1	Write constrain conflict
		2	Resource busy
		3	Resource unavailable
		4 to 7	Reserved
		8 to 15	Device specific
13 to 15	Device Specific	0 to 15	Device specific

Error Code 2

Error Code 2 is Device specific. Please refer to the user documentation of that slave for further details.

DP-V1 Alarm Acknowledge (9)

The master uses the DP-V1 Alarm Status Block to perform a DP-V1 Alarm acknowledgement to a slave device. This message is sent to acknowledge and receive information about an alarm when the alarm information appears in the DP-V1 status words of the PLC. The information mapped to these words must be used in the DP-V1 Alarm Acknowledge command to process the alarm properly. The mapping of these words is as follows.

Word	Byte	Name	Description
1	Low	Slave Address	Address of slave with alarm
1	High	Slot Number	Slot number of alarm
2	Low	Alarm Type	Type of the alarm. (Valid values are 1—6 and 32—126.)
2	High (bits 0—2)	Alarm Spec	Alarm Specification. (Valid values are 0—7.)
2	High (bits 3—7)	Sequence Number	Alarm Sequence Number (Valid values are 0—31.)

DP-V1 Alarm Acknowledge Command Block

Word Offset	Value Dec (Hex)	Definition
1	9 (0009)	Length of command Data Block in words.
2	0 (0000)	Always 0 (no-wait mode request)
3	See page 5-5.	Memory type of COMMREQ status word. (Words 3 and 4 specify the starting address where the status word will be written.)
4	0-based offset	COMMREQ status word address minus 1. Example: if Words 3 and 4 contain values of 8 and 9 respectively, the status word will be written to %R10.
5	0 (0000)	Reserved
6	0 (0000)	Reserved
7	9 (0009)	Command code for the COMMREQ to be executed. DP-V1 Alarm Acknowledge = 9.
8	See page 5-5.	Memory type for the reply data.
9	0-based offset	Starting address to which the response will be written. The value entered is the 0-based offset from the beginning of PLC memory for the memory type specified in Word 8. This offset will be in bits, bytes, or words depending on the memory type specified. Valid ranges of values depend on the PLC's memory ranges. Example: If Words 8 and 9 contain values of 8 and 250 respectively, the response will be written to %R251.
10	Words: 7 (0007) Bytes: 14 (000E)	Size of response. If word memory type is used, must be 7. Must be 14 for discrete memory.
11	0—125 (0—007D)	Specifies the address of the device from which status will be retrieved. If the address of the master or a slave that is not on the bus is entered, a COMMREQ Status Word response of 4 will be returned.
12	0—254 (0—00FE)	Slot Number. Depends on the specific slave device. Please refer to the user documentation for the slave for further details.
13	0—31 (0—001F)	Sequence Number. Please refer to the user documentation for the slave for further details
14	1—6 and 32—126 (0020—007E)	Alarm Type. Depends on the specific slave device. Please refer to the user documentation for the slave for further details.
15	0—7	Alarm Spec. Please refer to the user documentation for the slave for further details

***DP-V1 Alarm Acknowledge Response Data Format –
Response written to location specified by Words 8 & 9***

Word	Name	Description
1	Command Code	Echo of the Command Code = 9
2	Slave Address	Echo of Slave address from command
3	Slot Number	Echo of Slot number from command
4	Sequence Number	Echo of Index from command
5	Alarm TYPE	Actual length of received data
6	Alarm Specifier	Additional information related to the alarm. See “DPV1 Alarm Specifier Codes” below.
7	Return Status	See “DPV1 Alarm Return Status Error Codes.”

DPV1 Alarm Specifier Codes

Code	Indication
00	No additional information
01	Error present and slot is not okay
10	Error resolved and slot is okay
11	Error resolved but slot is still not okay



DPV1 Alarm Return Status Error Codes

The tables below show the possible return messages contained in the Return Status word of the DPV1 Alarm Response.

Code	Name	Indication
134	REJ_INT	The alarm handler is not initialized.
135	REJ_SRT	The alarm handler is not initialized.
136	REJ_ENA	The alarm that has been acknowledged is not pending. It is possible that you have entered an incorrect Slot ID or Sequence number.
137	REJ_NPD	The alarm that has been acknowledged is not pending on a MSAL1_Alarm_Res.
154	REJ_COM	Unknown command.

Device Information Details

To obtain information about RX3i (IC695) modules installed in a target RX3i system, access the Device Information Details provided by Machine Edition software. This interface reports the rack/slot location, model number, primary and boot firmware versions and hardware version for each RX3i module in the system.

1. In the  Project tab of the Navigator, right click the  Target node. Choose the Online Commands menu and select Show Status. The status dialog box appears.

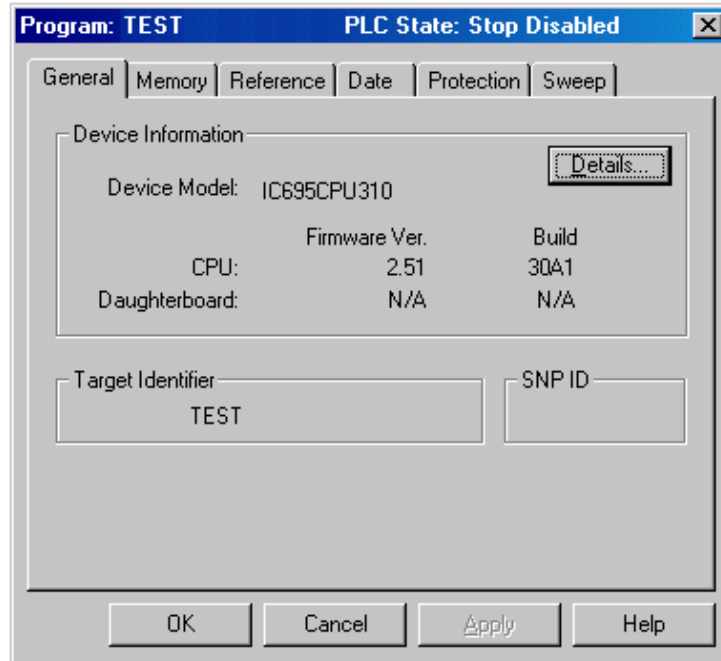

2. Click the Details button. The Device Information Details dialog box appears.

The screenshot shows a dialog box titled "Device Information Details" containing a table of installed modules. The table has columns for Location, Location ID, Model, Primary FW Rev, Boot FW Rev, and Hardware Rev. The data is as follows:

Location	Location ID	Model	Primary FW Rev	Boot FW Rev	Hardware Rev
Rack 0					
Slot 0	0.0	IC695PSA040	0.30	N/A	N/A
Slot 2	0.2	IC695CPU310	3.00 (06A2)	2.50 (25A3)	2.00
Slot 5	0.5	IC695ETM001	2.99 (51C1)	2.99 (50C1)	6.00
Slot 6	0.6	IC695PBM300	1.00 (V01.000)	1.51 (V01.510)	1.00
Slot 7	0.7	IC695PBS301	1.00 (V01.000)	1.51 (V01.510)	1.00

An "OK" button is located at the bottom right of the dialog box.

There are three methods for obtaining status and diagnostic data:

- Observing and interpreting the LED indicators on the PROFIBUS Slave Module, page 6-2
- Monitoring the Slave and DP-V1 Status registers, page 6-3
- Using Communications Request (COMMREQ) ladder logic instructions to instruct the PROFIBUS slave to gather diagnostic or status data and report it to the PLC CPU, page 6-4

Note: The PROFIBUS slave does not generate faults for the Fault Table.

PROFIBUS Slave Module LEDs

The slave module provides three PROFIBUS-compliant LEDs that indicate module and network status.

LED	Color	State	Frequency	Meaning
PROFIBUS OK	Green	Static	NA	Module has power and backplane reset complete.
		Off	NA	Module does not have power or backplane reset not complete.
NETWORK	Yellow	Static On	NA	Module is able to transmit PROFIBUS telegrams.
		Off	NA	No exchange of PROFIBUS telegrams.
	Red	Static On	NA	A critical problem, such as handshake timeout, was encountered.
MOD STATUS	Green	Flashing, Cyclic	5 Hz	No error in configuration found; module is ready for configuration; it tries to open a connection, but is not connected yet.
		Flashing, Non-cyclic	Three times fast at 5 Hz, Eight times between 0.5 Hz and 1 Hz	Powerup: Configuration missing. For details on hardware configuration, refer to Chapter 4. Runtime: Firmware has found a critical problem, such as a watchdog timeout.
		Static On	NA	Module has established a connection to the network master.
	Yellow	Flashing, Cyclic	1 Hz	Module is in boot-loader mode and is waiting for firmware download.
		Flashing, Cyclic	5 Hz	Firmware download is in progress.
		Flashing, Non-cyclic	Three times fast at 5 Hz, Eight times between 0.5 Hz and 1 Hz	Hardware or non-recoverable runtime error detected. Module needs to be replaced.
	Off	NA	NA	No power

Status Registers

Slave Status

The starting reference address for this two-word array is set in the PROFIBUS slave software configuration. For details, see “PROFIBUS Slave Parameters” in chapter 4.

Word	Name	Description
1	Slave Status	This word contains the slave status code. The status can be read using the Get Slave Status COMMREQ (command 3), described on page 6-4.
2	Reserved	Always 0.

Word 1 – Slave Status Word

Bits	Meaning	Value
15—12	Baud Rate (bps)	0=12MBit/s, 1=6MBit/s, 2=3MBit/s, 3=1.5MBit/s, 4=500Kbit/s, 5=187.5Kbit/s, 6=93.75Kbit/s, 8=19.2Kbit/s, 9=9.6Kbit/s Note: Baud rate value is valid only if module is connected to the PROFIBUS network.
11—10	Module State	0=Module is waiting for parameters from master 1=Module is waiting for configuration from master 2=Data Exchange is occurring – normal operation 3=Error (either configuration error or module watchdog timeout)
9	On-line	1=Online module firmware is running 0=Offline
8	PLC Cfg	0= Module configuration from CPU is bad 1=Module configuration from CPU is good
7	Run/Stop	This is the state of the PROFIBUS Master. 0=Stop or Clear mode 1=Operate (Run) mode
6—0	Error Info	Contains the Slave Last Error code, which is the same as that returned in word 2 of the Get Slave Status COMMREQ reply data. For error code definitions, see “Slave Last Error Codes” on page 6-6.

DP-V1 Status

This two-word array is used at the beginning of a scan to monitor the DP-V1 master messages. Its starting address is set in the PROFIBUS slave software configuration. For details, see “PROFIBUS Slave Parameters” in chapter 4.

DPV1 Read Indication

DP-V1 Status Register 1			DP-V1 Status Register 2	
Bit 15	Bit 14—8	Bit 7—0	Bit 15—8	Bit 7—0
0	Master Address	Data Size	Slot	Index

DPV1 Write Indication

DP-V1 Status Register 1			DP-V1 Status Register 2	
Bit 15	Bit 14—8	Bit 7—0	Bit 15—8	Bit 7—0
1	Master Address	Data Size	Slot	Index

Communication Requests

The Communication Request function (COMMREQ) allows the program to communicate with a GE Intelligent Platforms module, such as a PROFIBUS slave. For details on the operation of the COMMREQ function block, refer to appendix A.

The figure below illustrates the flow of information between the PLC CPU and the PROFIBUS slave.

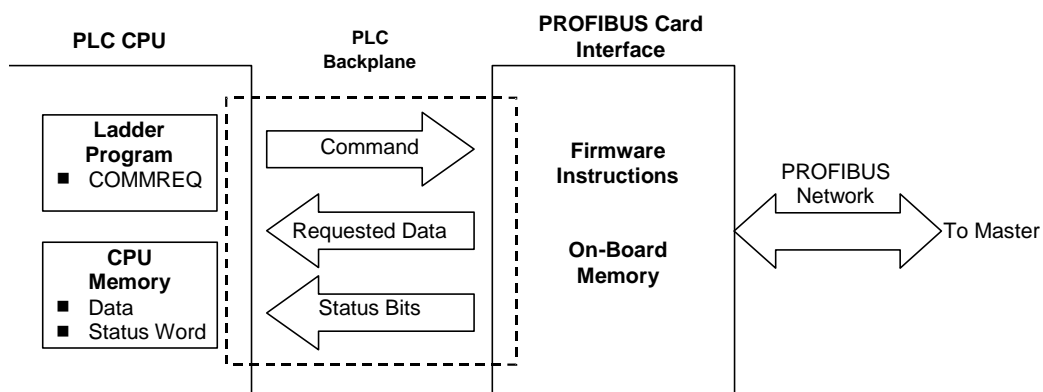

Communications Request Operation for PROFIBUS Slave

The PROFIBUS slave supports the following COMMREQ commands and responses.

PROFIBUS Slave COMMREQs

Command Code	Name	Description	Page No.
3	Get Slave Status	Retrieves detailed status information for the slave.	6-5
5	Read Module Header	Retrieves module header information.	6-7
6	Clear Counters	Clears counters in Read Module Header	6-9
7	DP-V1 Read Response	Sends a response to a DP-V1 Read Indication from the PROFIBUS master.	6-10
8	DP-V1 Write Response	Sends a response to a DP-V1 Write Indication from the PROFIBUS master.	6-12
9	DP-V1 Alarm Request	Sends a DP-V1 alarm indication to a DP-V1 master.	6-14

The following table lists the memory types that can be used for the Status Block and Reply Data areas.

COMMREQ Status Word Memory Type Codes

Memory Type	Memory Type	Decimal Code
%I	Discrete input table (Byte mode)	16
%Q	Discrete output table (Byte mode)	18
%R	Register memory	8
%W	Word memory	196
%AI	Analog input table	10
%AQ	Analog output table	12
%T	Discrete temporary memory (Byte)	20
%M	Discrete internal memory (Byte)	22

Get Slave Status COMMREQ (3)

The Get Slave Status COMMREQ retrieves detailed status information for the slave device from the 16-bit slave status word. The starting address of this word is configured as Status Address in the PROFIBUS slave software configuration. For details, refer to “PROFIBUS Slave Parameters” in chapter 4.

Get Slave Status Command Block

Word Offset	Value Dec (Hex)	Definition
Word 1	4 (0004)	Length of command Data Block in words
Word 2	0 (0000)	Always 0 (no-wait mode request)
Word 3	See page 6-4.	Memory type of COMMREQ status word. (Words 3 and 4 specify the starting address where the status word will be written.)
Word 4	0-based offset	COMMREQ status word address minus 1. Example: If Words 3 and 4 contain values of 8 and 9 respectively, the status word will be written to %R10.
Word 5	0 (0000)	Reserved
Word 6	0 (0000)	Reserved
Word 7	3 (0003)	Command code for the COMMREQ to be executed. Get Module Status = 3.
Word 8	See page 6-4.	Memory type for the reply data. (Words 8—9 specify the starting address where the response will be written.)
Word 9	0-based offset	Starting address to which the response will be written. The value entered is the 0-based offset from the beginning of PLC memory for the memory type specified in Word 8. This offset will be in bits, bytes, or words depending on the memory type specified. Valid ranges of values depend on the PLC’s memory ranges. Example: If Words 8 and 9 contain values of 8 and 250 respectively, the response will be written to %R251.
Word 10	Words: 9 (0009) Bytes: 18 (0012)	Maximum size of response area Must be 9 if word memory type is used; 18 if discrete memory type is used, or an error will be reported in the COMMREQ status and the Get Slave Status request will be ignored.

Get Slave Status - Reply Data Format

Word	Name	Description
Word 1	CommandCode	Echo of Command code that this data block is replying to. (0x0003)
Word 2	Last Error	See "Slave Last Error Codes" below.
Word 3	Running State	Word values: xxx1 – Slave in initialization state. If slave remains in this state the slave hardware configuration has an error. xx1x – Slave initialized without error. x1xx – Slave diagnostics information is being sent. 1xxx – Data exchange is active with master. Example: A value of 0x1010 (4112 decimal) indicates that the slave has been initialized without error and is exchanging data with the master.
Word 4	Baud Rate	0 = 12 MBit/s, 1 = 6 MBit/s, 2 = MBit/s, 3 = 1.5 MBit/s, 4 = 500 kBit/s, 5 = 187.5 kBit/s, 6 = 93.75 kBit/s, 8 = 19.2 kBit/s, 9 = 9.6 kBit/s Note: Baud rate value is valid only if module is connected to the PROFIBUS network.
Words 5 - 9	NA	Reserved.

Slave Last Error Codes

The following error codes may be returned in word 2 of the Get Slave Status COMMREQ reply data or word 6 of the Read Module Header COMMREQ reply data (page 6-8).

Value Dec (Hex)	Meaning
0 (0000)	No error. Slave is running properly.
52 (0034)	DPS_ERR_INIT_BUS_ADDRESS. Invalid bus address configured, valid addresses are 1 ... 125
53 (0035)	DPS_ERR_INIT_WAIT_FOR_WARMSTART. Application has not made a warm start to the slave yet.
54 (0036)	DPS_ERR_INIT_MODULE_TYPE. Invalid module type configured. The configured module type code is unknown.
55 (0037)	DPS_ERR_INIT_MODULE_LENGTH. Invalid module length. The code for the parameter module length is not defined.
70 (0046)	DPS_ERR_INIT_IO_LEN. Invalid length of I/O data. The maximum length of I/O data has been exceeded or no I/O modules were specified.
72 (0048)	DPS_ERR_INIT_DPV1_C1_BUF_LEN. Illegal DP-V1 class 1 buffer length.
73 (0049)	DPS_ERR_INIT_DPV1_C2_BUF_LEN. Illegal DP-V1 class 2 buffer length.
74 (0050)	DPS_ERR_INIT_SPC3_NOFF. PROFIBUS slave chip not in offline mode during initialization.
75 (0051)	DPS_ERR_INIT_SPC3_LESS_MEM. Not enough memory in SPC3 for all buffers.
76 (0052)	DPS_ERR_INIT_DIN_DOUT_BUF_LEN. Illegal I/O data buffer length.
77 (0053)	DPS_ERR_INIT_DIAG_BUF_LEN. Illegal diagnostic buffer length.
78 (0054)	DPS_ERR_INIT_PRM_BUF_LEN. Illegal parameter buffer length.
79 (0055)	DPS_ERR_INIT_CFG_BUF_LEN. Illegal configuration buffer length.
80 (0056)	DPS_ERR_INIT_SSA_BUF_LEN. Illegal SSA buffer length.

Read Module Header (5)

The Read Module Header command retrieves Network Diagnostic Information for the device.

Read Module Header Command Block

Word Offset	Value Dec (Hex)	Definition
Word 1	4 (0004)	Length of command Data Block in words
Word 2	0 (0000)	Always 0 (no-wait mode request)
Word 3	See page 6-4.	Memory type of COMMREQ status word. (Words 3 and 4 specify the starting address where the status word will be written.)
Word 4	0-based offset	COMMREQ status word address minus 1. Example: If Words 3 and 4 contain values of 8 and 9 respectively, the status word will be written to %R10.
Word 5	0 (0000)	Reserved
Word 6	0 (0000)	Reserved
Word 7	5 (0005)	Command code for the COMMREQ to be executed. Read Module Header = 5.
Word 8	See page 6-4.	Memory type for the reply data. (Words 8—9 specify the starting address where the response will be written.)
Word 9	0-based offset	Starting address to which the response will be written. The value entered is the 0-based offset from the beginning of PLC memory for the memory type specified in Word 8. This offset will be in bits, bytes, or words depending on the memory type specified. Valid ranges of values depend on the PLC's memory ranges. Example: If Words 8 and 9 contain values of 8 and 250 respectively, the response will be written to %R251.
Word 10	Words: 12 (000C) Bytes: 24 (0018)	Size of response area: 12 for word memory type; 24 for discrete memory type. If the Response Memory Size is set smaller, the COMMREQ will fail with a 7 in the COMMREQ Status Word. You are responsible for assuring that this area is large enough to contain the requested data without overwriting other application data

Read Module Header Reply Data Format for Slave

Word	Name	Description								
1	Command Code	Echo of the Command Code = 5.								
2	Interface Type	2 if the interface is a master. 1 if the interface is a slave.								
3	Firmware Revision	Indicates the current firmware revision. High Byte is major version number. Low Byte is minor version number.								
4	Slave Bus Address	Address of slave in active bus.								
5	Ident Number	PROFIBUS identification number.								
6	Last Error	Last Error reported from slave. See "Slave Last Error Codes" on page 6-6.								
7	Running State	<p>Word values:</p> <ul style="list-style-type: none"> xxx1 – Slave in initialization state. If slave remains in this state the slave hardware configuration has an error xx1x – Slave initialized without error. x1xx – Slave diagnostics information is being sent. 1xxx – Data exchange is active with master. <p>Example: A value of 0x1010 (4112 decimal) indicates that the slave has been initialized without error and is exchanging data with the master.</p>								
8	Baud Rate	<p>0 = 12 MBit/s, 1 = 6 MBit/s, 2 = MBit/s, 3 = 1.5 MBit/s, 4 = 500 kBit/s, 5 = 187.5 kBit/s, 6 = 93.75 kBit/s, 8 = 19.2 kBit/s, 9 = 9.6 kBit/s</p> <table border="1" style="width: 100%; border-collapse: collapse;"> <thead> <tr> <th style="text-align: center;">State</th> <th style="text-align: center;">Word 8 Value</th> </tr> </thead> <tbody> <tr> <td>Slave is configured and connected to the network</td> <td>Current baud rate</td> </tr> <tr> <td>Slave is disconnected from the network</td> <td>Last baud rate</td> </tr> <tr> <td>Slave was not connected to the master (auto baud)</td> <td>A number between 0 and 9</td> </tr> </tbody> </table>	State	Word 8 Value	Slave is configured and connected to the network	Current baud rate	Slave is disconnected from the network	Last baud rate	Slave was not connected to the master (auto baud)	A number between 0 and 9
State	Word 8 Value									
Slave is configured and connected to the network	Current baud rate									
Slave is disconnected from the network	Last baud rate									
Slave was not connected to the master (auto baud)	A number between 0 and 9									
9	Error Count	A count of errors that have occurred since start.								
10	I/O Length	Size of the I/O for the slave.								
11	Module Count	Number of modules configured.								
12	Reserved	Reserved.								

Clear Counters (6)

The Clear Counters Command sets the counters in the PROFIBUS module to zero.

Clear Counters Command Block

In the following command block, Status is returned in %R251—%R252 (words 8 and 9).

Word Offset	Value Dec (Hex)	Definition
Word 1	4 (0004)	Length of command Data Block in words
Word 2	0 (0000)	Always 0 (no-wait mode request)
Word 3	See page 6-4.	Memory type of COMMREQ status word. (Words 3 and 4 specify the starting address where the status word will be written.)
Word 4	0-based offset	COMMREQ status word address minus 1. Example: If Words 3 and 4 contain values of 8 and 9 respectively, the status word will be written to %R10.
Word 5	0 (0000)	Reserved
Word 6	0 (0000)	Reserved
Word 7	6 (0006)	Command code for the COMMREQ to be executed. Clear Counters = 6.
Word 8	See page 6-4.	Memory type for the reply data. (Words 8—9 specify the starting address where the response will be written.)
Word 9	0-based offset	Starting address to which the response will be written. The value entered is the 0-based offset from the beginning of PLC memory for the memory type specified in Word 8. This offset will be in bits, bytes, or words depending on the memory type specified. Valid ranges of values depend on the PLC's memory ranges. Example: If Words 8 and 9 contain values of 8 and 250 respectively, the response will be written to %R251.
Word 10	Words: 2 (0002) Bytes: 4 (0004)	Maximum size of response area. The Response Memory Size must be set to 2 if word memory is used, 4 if discrete memory is used, otherwise the COMMREQ will fail.

Clear Counters Reply Data Format

Word	Name	Description
Word 1	CommandCode	Echo of Command code = 6
Word 2	StatusCode	Reports 1 for success and 0 for failure.

DP-V1 Read Response (7)

Read Response Command Block

When a DP-V1 master executes a Read Request to a slave, an indication will appear in the DP-V1 status register of the PLC. The application program must use this information in order to formulate the appropriate COMMREQ response to the master's request. The response format for this COMMREQ is as follows.

Word Offset	Value Dec (Hex)	Definition
1	8+x (0008+x)	Length of command block in words.
2	0 (0000)	Always zero - no wait mode request.
3	See page 6-4.	Memory type of COMMREQ status word. (Words 3 and 4 specify the starting address where the status word will be written.)
4	0-based offset	COMMREQ status word address minus 1. Example: If Words 3 and 4 contain values of 8 and 9 respectively, the status word will be written to %R10.
5	0 (0000)	Reserved.
6	0 (0000)	Reserved.
7	7 (0007)	Command code for the COMMREQ to be executed. Read Response = 7.
8	See page 6-4.	Memory type for the reply data. (Words 8—9 specify the starting address where the response will be written.)
9	0-based offset	Starting address to which the response will be written. The value entered is the 0-based offset from the beginning of PLC memory for the memory type specified in Word 8. This offset will be in bits, bytes, or words depending on the memory type specified. Valid ranges of values depend on the PLC's memory ranges. Example: If Words 8 and 9 contain values of 8 and 250 respectively, the response will be written to %R251.
10	Words: 6 (000C) Bytes: 12 (000C)	Maximum size of response area (6 for word memory type, 12 for discrete memory type).
11	0—125 (0000—007D)	Master address (range 0 - 125), read from DP-V1 status register.
12	0—254 (0000—00FE)	Slot. Depends on the application.
13	0—254 (0000—00FE)	Index. Depends on the application.
14	y	Size y of data to be written. Maximum value of y is 120 words or 240 bytes. See note on page 6-11.
14 + y	0 to 65535 (0 to FFFF)	Data to be written.

Note: The slave can respond to master DPV1 read requests for data in odd byte sizes even though the read data size in the DPV1 Status register (described on page 6-3) and the DPV1 Read Response COMMREQ is in number of words. If a request for an odd byte length is made, the DPV1 Status in reference memory will indicate a read size rounded up to the nearest word, but the DPV1 Read response on the PROFIBUS network will only be for the size requested.

For example, if a master requests a DPV1 read of 5 bytes, the DPV1 Read request size in the DPV1 Status reference memory will be 3 words (6 bytes). The slave must also respond with a DPV1 Read Response COMMREQ with data size of 3 words. However, the PROFIBUS network response back to the master will be based on the original request size, so only 5 bytes of response data are transmitted (the last byte is discarded).

Read Response Reply Data Format

<i>Word</i>	<i>Name</i>	<i>Description</i>
1	Command Code	Echo of Command code = 7
2	Master Address	Echo of master address from command
3	Slot Number	Echo of Slot Number from command
4	Index	Echo of Index from command
5	Length	Actual length of data sent. If word memory type is specified in Word 8 of the command block, Length is in words. If discrete memory type is specified, Length is in bytes.
6	ReadResStat (Read Response Status)	0 = Successful 1 = Unsuccessful
7—12	Reserved	Reserved

DP-V1 Write Response (8)

Write Response Command Block

When a DP-V1 master executes a Write Request to a slave, an indication will appear in the DP-V1 status register of the PLC. The application program must use this information in order to formulate the appropriate COMMREQ response to the master's request. The response format for this COMMREQ is as follows.

Word Offset	Value Dec (Hex)	Definition
1	7 (0007)	Length of command block in words.
2	0 (0000)	Always zero - no wait mode request.
3	See page 6-4.	Memory type of COMMREQ status word. (Words 3 and 4 specify the starting address where the status word will be written.)
4	0-based offset	COMMREQ status word address minus 1. Example: If Words 3 and 4 contain values of 8 and 9 respectively, the status word will be written to %R10.
5	0 (0000)	Reserved.
6	0 (0000)	Reserved.
7	8 (0008)	Command code for the COMMREQ to be executed. Write Response = 8.
8	See page 6-4.	Memory type for the reply data. (Words 8—9 specify the starting address where the response will be written.)
9	0-based offset	Starting address to which the response will be written. The value entered is the 0-based offset from the beginning of PLC memory for the memory type specified in Word 8. This offset will be in bits, bytes, or words depending on the memory type specified. Valid ranges of values depend on the PLC's memory ranges. Example: If Words 8 and 9 contain values of 8 and 250 respectively, the response will be written to %R251.
10	Words: 6+x (0006+x) Bytes: 12+x (C+x)	Maximum size of response area. The maximum value of x is 120 if word memory type is used (240 bytes if discrete memory is used). The length is always a minimum of 6 words (12 bytes) plus the actual DP-V1 data length x. x ranges from 1 to 120 if word type memory is used and from 1 to 240 if discrete memory is used. For example, if the expected length of the DP-V1 indication COMMREQ is 8 words, word 10 should be 6 + 8 = 14.
11	0—125 (0000—007D)	Master address (range 0 - 125), read from DP-V1 status register.
12	0—254 (0000—00FE)	Slot. Depends on the application.
13	0—254 (0000—00FE)	Index. Depends on the application.

Write Response Reply Data Format

Word	Name	Description
1	Command Code	Echo of Command code = 8
2	Master Address	Echo of master address from command
3	Slot Number	Echo of Slot Number from command
4	Index	Echo of Index from command
5	Length	Actual length of data received. If word memory type is specified in Word 8 of the command block, Length is in words. If discrete memory type is specified, Length is in bytes.
6	WriteResStat (Read Response Status)	0 = Successful 1 = Unsuccessful
6+x	Data	Data received (0 to 65535 (0 to FFFF))
...	...	Data received (0 to 65535 (0 to FFFF))

DP-V1 Alarm Request (9)

The slave can send DP-V1 alarm indications to a master. The format of this COMMREQ is as follows.

Alarm Request Command Block

Word Offset	Value Dec (Hex)	Definition
1	9+x (0009+x)	Length of command block in words.
2	0 (0000)	Always zero - no wait mode request.
3	See page 6-4.	Memory type of COMMREQ status word. (Words 3 and 4 specify the starting address where the status word will be written.)
4	0-based offset	COMMREQ status word address minus 1. Example: If Words 3 and 4 contain values of 8 and 9 respectively, the status word will be written to %R10.
5	0 (0000)	Reserved
6	0 (0000)	Reserved
7	9 (0009)	Command code for the COMMREQ to be executed. Alarm Request = 9.
8	See page 6-4.	Memory type for the reply data. (Words 8—9 specify the starting address where the response will be written.)
9	0-based offset	Starting address to which the response will be written. The value entered is the 0-based offset from the beginning of PLC memory for the memory type specified in Word 8. This offset will be in bits, bytes, or words depending on the memory type specified. Valid ranges of values depend on the PLC's memory ranges. Example: If Words 8 and 9 contain values of 8 and 250 respectively, the response will be written to %R251.
10	Words: 6 (0006) Bytes: 12 (000C)	Maximum size of response area. (6 for word memory type, 12 for discrete memory type).
11	0—254 (0000—00FE)	Slot. Value depends on the specific application.
12	0—31 (0000—001F)	Sequence Number. The sequence number is used to determine alarms that are active at the same time. Thus the sequence number must be unique to each alarm.
13	0—254 (0000—00FE)	Alarm Type. Application specific.
14	0 (0000)	Alarm Specifier (should always be 0)
15	y (y)	Alarm Size. Specifies the amount of data (y) to be transmitted in this COMMREQ. Maximum value of y is 32 bytes. Alarm Size is 0 (zero) if no data needs to be transmitted to the master. Always word length regardless of command block memory type.
16+y	0-65535 (0000-FFFF)	Data to be sent. This optional field can be used to transmit additional alarm relevant data to the master. The length of the data must be entered in the Alarm Size field.

Alarm Request Reply Data Format

Word	Name	Description
1	Command Code	Echo of Command code = 9
2	Slot Number	Echo of Slot Number from command
3	Sequence Number	Echo of Sequence Number from command
4	Alarm Type	Echo of Alarm Type from command
5	Alarm Specifier	Echo of Alarm Specifier from command
6	Return Status	See "Return Status Codes" table below.
7	Reserved	Reserved

Return Status Codes

Value Dec (Hex)	Meaning
0 (0000)	No Error
115 (0073)	Status data exceeds the length of the SPC3 diagnostic buffer
116 (0074)	No diagnostic buffer available at the moment (this is a temporary error.)
119 (0077)	DP-V1 class 1 services are disabled
120 (0078)	Maximum number of active alarms exceeded
121 (0079)	Alarm is disabled
123 (0081)	User specific alarm data out of range
125 (0083)	Sequence number out of range or already in use
152 (0098)	Unknown command code
165 (00A5)	Length mismatch
200 (00C8)	Task not initialized

The Communication Request function (COMMREQ) allows the program to communicate with a GE Intelligent Platforms module, such as a PROFIBUS master or slave.

The COMMREQ function uses a *command block* that contains the data to be communicated to the device, plus information related to the execution of the COMMREQ. The command block must be placed in the designated memory area using data move instructions, such as MOVE or BLKMOV (Block Move).

The CPU reports the result of the COMMREQ in the *status word*, which is a single location in PLC data memory. The status word address is specified in the command block. For a list of status codes reported in the status word, see “COMMREQ Status Word” on page A-4.

For details on the COMMREQ tasks supported by the PROFIBUS Master module, see chapter 4.

This appendix provides an overview of the COMMREQ instruction. For details of the COMMREQ ladder instruction, refer to the online help provided with the programming software.

COMMREQ Ladder Instruction

A Communications Request is initiated when a COMMREQ ladder instruction is activated during the PLC scan. At this time, a command from the PLC via the Communications Request is sent to the PROFIBUS device.

At the conclusion of every request, the CPU reports the status of the request to the Status Word, which is a location in PLC memory that is designated by the Status Word Pointer in the Command Block.

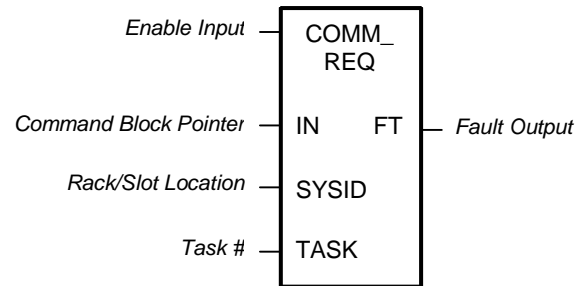

The COMMREQ ladder instruction has four inputs and one output:

Enable Input: Must be Logic 1 to enable the COMMREQ Instruction. It is recommended that the enabling logic be a contact from a transition (“one-shot”) coil.

IN: The memory location of the first word of the Command Block. It can be any valid address in word-type memory (%R, %AI, or %AQ). For example, %R00100 at IN would indicate that the starting address of the Command Block is %R00100.

SYSID: A hexadecimal value that gives the rack and slot location of the target device. The high byte (first two digits of the hex number) contains the rack number, and the low byte contains the slot number.

SYSID Example

Rack	Slot	Hex Word Value
0	4	0004h

TASK: Must be 1 for the PROFIBUS module.

FT Output: The function's FT (fault) output can provide an output to optional logic that can verify successful completion of the Communications Request. The FT output can have these states:

<i>FT Output Truth Table</i>		
<i>Enable Input Status</i>	<i>Does an Error Exist?</i>	<i>FT output</i>
Active	No	Low
Active	Yes	High
Not active	No execution	Low

- The FT output is set High if:
 - The specified target address is not present (for example, specifying Rack 1 when the system only uses Rack 0).
 - The specified task number is not valid for the device.
 - Data length is set to 0.
- The FT output can either be connected to another device, such as a set coil, or can be left open.

COMMREQ Programming Requirements and Recommendations

- COMMREQ instructions should be enabled by a contact from a transition coil.
- If using more than one COMMREQ in a ladder program, verify that a previous COMMREQ executed successfully before executing another one. This can be done by checking the Status Word and the FT (Fault) output.
- The FT output is held False if the Enable Input is not active. This means that if the COMMREQ is enabled by a transitional (one-shot) contact and a fault occurs, the FT output is High for only one PLC scan. To capture the fact that a fault occurred, you can program the fault output as a Set coil, which would not be automatically reset at the end of a scan. Additional logic would then be needed to reset the fault output coil after the fault is acknowledged and before the next execution of the COMMREQ.
- Programming a device, such as a Set Coil, on the FT output of the COMMREQ is optional; this output may be left open if desired.
- It is necessary to initialize the data in the Command Block before executing the COMMREQ instruction. Since the normal PLC sweep order is from top to bottom, initializing the Command Block in an earlier rung (or rungs) than the rung that contains the COMMREQ will satisfy this requirement.
- If you use MOVE instructions to load values into Command Block registers, use a Word-type MOVE to load a hexadecimal number, and an Integer-type MOVE to load a decimal number.

Error Detection and Handling

As shown in “COMMREQ Status Word”, a value of 1 is returned to the Status Word if communications proceed normally, but if any error condition is detected, a value greater than 1 is returned. If you require error detection in your ladder program, you can use a Greater Than (GT) compare instruction to determine if the value in the Status Word is negative (less than zero). If an error occurs, the GT instruction’s output (Q) will go high. A coil driven by the output can be used to enable fault handling or error reporting logic.

The FT output of the COMMREQ, goes high for certain faults and can also be used for fault detection. Additionally, the first Status Word can be monitored by error message logic for display on an Operator Interface device, in which case, Status Word codes correspond to the error messages that appear on the operator screen.

To dynamically check the Status Word, write a non-significant positive number (0 or 99 are typically used) into the Status Word each time before its associated COMMREQ is executed. If the instruction executes successfully, the CPU will write the number 1 there. This method lets you know that if the number 1 is present, the last COMMREQ definitely executed successfully, and that the 1 was not just left over from a previous execution.

When multiple COMMREQs are used, each should be verified for successful communications before the next is enabled. Monitoring the Status Word is one way to accomplish this.

Corrective Actions for COMMREQ Errors

The type of corrective action to take depends upon the application. If an error occurs during the startup or debugging stage of ladder development, you should verify the COMMREQ parameters. The same is true if an error occurs right after a program is modified. But, if an error occurs in a proven application that has been running successfully, the problem is more likely to be hardware-related. The PLC fault tables should be checked for additional information when troubleshooting Status Word errors.

COMMREQ Status Word

The following table defines the state codes that can be returned in the COMMREQ status word.

Value Dec (Hex)	Description
0 (0000)	Device has not yet processed the COMMREQ.
1 (0001)	Command Complete Note: This status does not necessarily mean success. Some commands have reply data that must also be checked.
2 (0002)	Command Terminated – module busy
3 (0003)	Command Terminated – invalid command
4 (0004)	Command Terminated – invalid command data
5 (0005)	Command Terminated – not enough data
6 (0006)	Not used
7 (0007)	Command Terminated – not enough memory in reply area The command did not specify sufficient PLC memory for the reply. Command will be ignored.
8 (0008)	Command Terminated – command-specific error. See AdditionalCode in the Status Block for more information.

A

Adding module to configuration, 3-1
 Adding slave devices, 3-10

C

Cable specifications, 2-4
 Clear Counters (6), 5-16, 6-9
 COMMREQs
 Clear Counters (6), 5-16, 6-9
 DP-V1 Alarm Acknowledge (9), 5-22
 DP-V1 Alarm Request (9), 6-14
 DP-V1 Read Request (7), 5-17
 DP-V1 Read Response (7), 6-10
 DP-V1 Write Request (8), 5-19
 DP-V1 Write Response (8), 6-12
 Get Device Diagnostics (4), 5-13
 Get Device Status (1), 5-6
 Get Master Status (2), 5-8
 Get Slave Status, 6-5
 Read Module Header (5), 5-14, 6-7
 Task ID, A-2
 COMMREQs, general information
 error detection and handling, A-3
 ladder instruction, A-2
 master, 5-5
 memory type codes, 5-5
 programming recommendations, A-3
 slave, 6-4
 status word, A-4
 Configuration
 adding slave devices, 3-10
 master network settings, 3-5
 PROFIBUS master, 3-1
 PROFIBUS slave, 4-1
 Configuration identifier, 1-7, 3-13
 Connectors
 network, 1-6, 2-3
 Consistency, data, 1-7

D

Data consistency, 1-7
 Device information, 5-24
 DP-V1 Alarm Acknowledge (9), 5-22
 DP-V1 Alarm Request (9), 6-14
 DP-V1 Read Request (7), 5-17
 DP-V1 Read Response (7), 6-10
 DP-V1 setup parameters, 3-16
 DP-V1 status
 read indication, 6-3
 write indication, 6-3
 DP-V1 Write Request (8), 5-19
 DP-V1 Write Response (8), 6-12

F

Fault table entries, 5-4
 Firmware ID, 5-24
 Firmware upgrades, 1-2, 1-3

G

Get Device Diagnostics, 5-13
 Get Device Status, 5-6
 Get Master Status, 5-8
 Get Slave Status, 6-5
 GS? files, 3-10, 3-14, 3-15, 5-11

I

Indicators
 PBM300, 5-2
 Installation procedures, 2-1
 connecting the module to the PROFIBUS
 network, 2-3
 installing network termination, 2-5
 system power requirements, 2-1

L

LEDs
 PBM300, 5-2
 PBS301, 6-2

N

Network segment length, 2-3
 Network termination, 2-5

O

Overview, 1-1

P

Parameters
 PROFIBUS master, 3-2
 PROFIBUS slave, 4-2
 Pin-out
 PROFIBUS bus connector, 1-6
 PLC fault table entries, 5-4
 Power consumption, 1-2, 1-3
 Power requirements
 system, 2-1
 PROFIBUS
 additional information, 1-1
 baud rate, 2-6
 bus communication, 1-4
 cable types, 2-4

- network connectors, 1-6
- network overview, 1-4
- network topology, 1-5
- PROFIBUS Master
 - overview, 1-2

R

- Read Module Header, 5-14, 6-7
- Redundant masters, 3-1
- RX3i information, 1-1

S

- Selecting the proper line type, 2-3
- Slave diagnostics/firmware ID array, 5-3
- Slave status bit array, 5-3
- Specifications
 - cable, 2-4
 - master module, 1-2
 - slave module, 1-3
- Status
 - DP-V1, 6-3
 - slave status, 6-3
- Status and diagnostic methods, 6-1
 - master, 5-1
- Status Word codes, COMMREQ, A-4

T

- t_bit, 3-6
- Task ID
 - COMMREQ, A-2